

FOBO ULTRA For RV

User Manual

(For FOBO Ultra 2 App only)

Version 1.0

(For iOS 12.0 and Android 5.0 or later)

Contents

1. Introduction
2. About FOBO Ultra
3. Importance of Tire Care
4. Product Description of FOBO Ultra
 - 4.1 In-Car Unit/Repeater
 - 4.2 Tire Sensor Unit
 - 4.3 Extension Valve & Screw on T-Valve
 - 4.4 In-Car Unit Mounting and Proposed Location
 - 4.5 Repeater Mounting and Proposed Location
5. Using FOBO Ultra
 - 5.1 Description of FOBO Ultra 2 App
 - 5.1.1 Login Page
 - 5.1.2 App Permission Requests
 - 5.1.3 Home Page
 - 5.1.4 Installation page
 - 5.1.5 Vehicle Settings Page
 - 5.1.6 Vehicle Details Page
 - 5.1.7 General Settings Page
 - 5.1.8 Profile List Page
 - 5.2 Installing FOBO Ultra 2 App
 - 5.3 Installing FOBO Ultra In-Car Unit and Sensors
 - 5.4 Sensor Rotation
 - 5.5 Disable Sensor and Replace New Sensor
 - 5.6 Release (Total/Sensor)
 - 5.7 Tire Inflation/Deflation
 - 5.8 Drop & Hook
 - 5.9 FOBO Portal
 - 5.10 FOBO Company
6. In-Car Unit Audio & LED Alerts
7. Replacing Battery – Sensor, In-Car and Repeater
8. Trouble Shooting Guide
9. FOBO Ultra Specifications

10. Warning
11. Regulatory Information
12. Intellectual Properties
13. Limited Warranty and Disclaimer

1. Introduction

FOBO Ultra is a Tire Pressure Monitoring System (TPMS) using Bluetooth Smart (Bluetooth 4.1 or later) technology to monitor your Truck, RV, Caravan tire pressure and temperature. Bluetooth Smart is a very low power wireless technology that could operate on a single coin cell battery for up to twelve months (**NOTE: Battery life may vary according to usage and climatic temperature. Operating under extreme cold may drastically reduce battery life.**)

Before starting to use FOBO Ultra, please download the free FOBO Ultra 2 App to your smartphone from Apple AppStore or Google Play Store. In addition, please ensure that your smartphone has Bluetooth Smart Ready (Bluetooth 4.1 or later) capability in order to use FOBO Ultra.

FOBO Ultra is a product designed and produced by Salutica Allied Solutions Sdn. Bhd. (“Salutica”), a Malaysian company with its address at No. 3, Jalan Zarib 6, Kawasan Perindustrian Zarib, 31500 Lahat, Ipoh, and Perak, Malaysia.

2. About FOBO Ultra

FOBO Ultra monitors your vehicle tires non-stop around the clock. Most drivers have encountered situations where they need to rush for an urgent delivery only to be stranded by a flat tire. Conventional Tire Pressure Monitoring Systems (TPMS) could not alert you in advance because it stops operating as soon as the Vehicle ignition is switched-off. With FOBO Ultra, you will get an alert as soon as the tire pressure drops below a certain pre-set level, even when the Vehicle ignition is switched off as long as you are within Bluetooth range (up to 30 meters with line of sight; but the range may reduce by obstacles in between). This alert gives you time to get the flat tire fixed before you need to use it.

You can receive data from the tire pressure sensors from all your vehicles without switching on the ignition. FOBO Ultra allows you to monitor your Vehicle tires conveniently at any time you want.

NOTE: Under certain conditions the signals from FOBO Ultra sensors may be blocked by surrounding objects or structures. If this occurs, please move around the vehicle in order to capture signals from all the tire sensors.

FOBO Ultra packaging consists of 4 wireless tire sensors, 1 wireless In-Car unit or Repeater a 12-24V 10 feet power cable with connector to Repeater or Power cable with USB to In-car unit. Replace your vehicle tire valve caps with the sensors and place the In-Car unit inside the cab. The sensors will measure tire pressure of each tire and transmit via Bluetooth to the In-Car unit and your smartphone. In case of a breach of pre-set threshold of tire pressure, the In-Car unit will produce an audible alert to notify you. An alert will also pop up on your smartphone if it is within Bluetooth range.

FOBO Ultra system requires a qualified smartphone and FOBO Ultra 2 App for installation. In addition to being able to view information regarding your vehicle tire pressure and temperature, the FOBO Ultra 2 App will also produce an alert when your tire has a problem.

DISCLAIMER: FOBO ULTRA IS NOT A DEVICE THAT PREVENTS ACCIDENTS. IT IS ALSO NOT A DEVICE THAT PREVENTS TIRES FROM BECOMING DEFLATED OR OVERINFLATED.

FOBO ULTRA IS NOT A SUBSTITUTE FOR SAFE TIRE MAINTENANCE PRACTICES. PLEASE CONTINUE TO TAKE PRECAUTIONARY MEASURES WHILE DRIVING AND TAKE FULL RESPONSIBILITY OF YOUR VEHICLE'S TIRE CONDITION TO ENSURE SAFETY WHILE DRIVING. YOU SHOULD CONTINUE TO PRACTICE PROPER TIRE CARE AND SCHEDULED TIRE MAINTENANCE.

3. Importance of Tire Care

It is extremely important to ensure vehicle tires are properly inflated for safety while driving. However, many drivers tend to neglect proper tire care and maintenance. The vehicle tires are the only contact points between the vehicle and the road. The weight of the vehicle and passengers are supported by the air pressure inside the tires. Improperly inflated vehicle tires may cause serious accidents on the road.

When tires are underinflated, the additional rolling resistance may cause build-up of heat which may lead to the de-lamination of the tire materials as well as damage to the tire's sidewall, which in turn increases the chances of a tire blow-out. Underinflated tires will also cause accelerated wear on the tire shoulders thereby causing uneven tire wear. Gas mileage will also be affected due to additional rolling resistance when driving with underinflated tires. You would also experience a significant loss of steering precision and cornering stability. Significantly under- inflated tires will also be less effective in resisting hydroplaning.

On the other hand, an overinflated tire will cause accelerated wear on the centre portion of the tire resulting in uneven tire wear. It would also result in a harsher ride and makes the tire more susceptible to damage when going over potholes or debris on the road.

What is the optimum tire pressure? There are a lot of information about this subject in internet forums and web articles. A quick guide for better understanding of tire pressure below: -

- 1) Vehicle manufacturers recommend the optimum tire pressure for their vehicle models. The information is usually available on a sticker at the door Jam (side of the driver's door) or in the owner's manual. For some vehicle models, the information sticker may be on the trunk lid or on the fuel door. Vehicle manufacturers usually recommend different tire pressure for front and rear axles. This pressure is usually recommended for comfort driving and optimum performance of the vehicle. It is not advisable to go below this recommended pressure level.
- 2) The vehicle manufacturer recommended tire pressure is "cold pressure". When you drive your vehicle to the gas station, the friction on the road will heat up your vehicle tires within a few minutes. Typically, there will 1 psi (~7kPa) increase in air pressure for every 10 deg F (5.6 deg C) rise in temperature. It is advisable to inflate the tire pressure with this compensated pressure above the recommended pressure.
- 3) Air pressure in tires is affected by changes in temperature. Check and adjust your tire pressure whenever there is a drastic change in environment temperature, e.g. Change of season.
- 4) A tire will normally lose its pressure through natural causes unless accelerated by a puncture, faulty valve or damaged wheels. It is advisable to change the tire valves or at least check the valves condition every time you change a new set of tires. Under normal condition, a set of tires could deflate at a rate of up to 2psi per month. It is good practice to check your tire pressure regularly and top up to the optimum pressure.

- 5) Every vehicle tire has a maximum inflation pressure. It is not advisable to inflate to the maximum inflation pressure of the tire. Follow the vehicle manufacturer's recommended tire pressure instead.

4 Product Description of FOBO Ultra

4.1 In-Car Unit



The functions of three action buttons are to correspond with the instruction that appears on the screen.

NOTE: Excessive frequent pressing on the buttons will drain the In-Car unit battery.

Status Indicator	Red LED will blink to show start-up mode or battery low status. Amber LED will blink to show alerts, low sensor battery and missing sensor.
Alert Buzzer	Buzzer to alert when there is problem with tire
AA Batteries	In-Car unit/Repeater operates with 5AA size batteries.

The FOBO Ultra In-Car unit/Repeater is a complex device that performs multiple functions. Due to the shielding effect of the vehicle chassis, some drivers may face difficulty in receiving the tire sensor signals on their smartphone when sitting inside the cab. This problem may be further aggravated when the driver places the smartphone in positions that are not optimal such as trouser pocket or waist pouch. The In-Car unit is designed with an efficient antenna that can pick up sensor signals better than a usual smartphone, enabling good signal reception from the tire sensors. Keep the In-Car unit in the cab and fix the Repeater in the centre of the Trailer for optimal functioning of FOBO Ultra. You may remove it for other sensor operation purposes, such as sensor position rotation and sensor disabling but place it back once the sensor operation is completed.

Note that In-Car unit is not waterproof.

FOBO Ultra In-Car Unit Dimensions in mm:

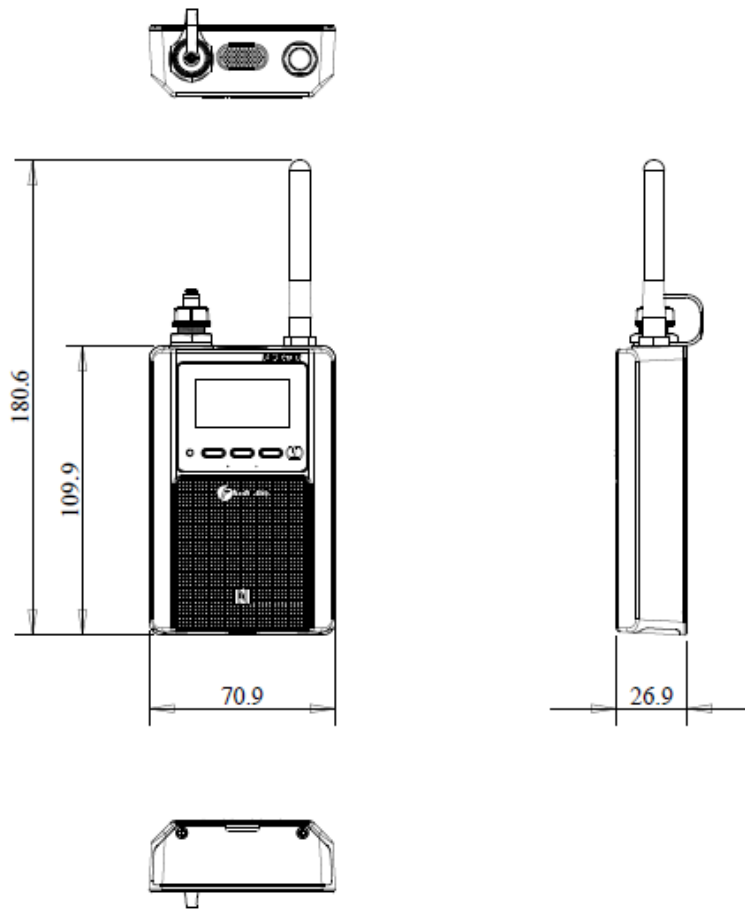

FOBO Ultra Repeater Unit Dimensions in mm:

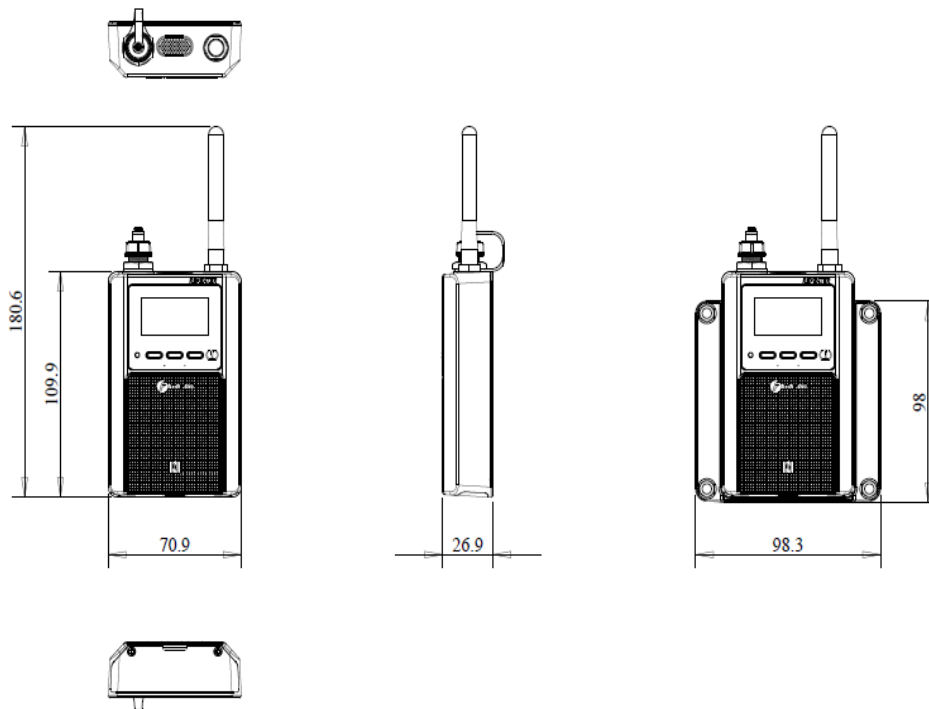

To conserve battery life, the In-Car unit/Repeater will go into ‘sleep’ mode after it detects that the vehicle has been stationary for more than 15 minutes. It will ‘wake up’ once it detects that the vehicle moves. You can still receive your tire pressure and temperature data by accessing the FOBO Ultra 2 App on the smartphone, even when the In-Car unit is asleep. This is due to FOBO Ultra sensor’s continuous operation of 24 x 7 which allows you to receive an alert even when the vehicle’s ignition is switched off.

The In-Car unit/Repeater is also designed to be a secondary alert device in the event of a deflated tire. This is to cover situations when you do not have your smartphone with you while driving or if your smartphone’s battery is dead. When there is a tire pressure alert, the In-Car unit/Repeater will produce an audible and visual LED alerts to inform you of a tire pressure problem.

Note: In the scenario if user planning not to use the vehicle which is installed with FOBO Ultra In-car unit/ Repeater unit for more than 1 week then it is advisable to remove the in-car unit/Repeater battery.

User have choice to choose the power source to power up the in-car unit/Repeater unit, they can choose to use Batteries (using 5AA Batteries) which are pre-installed in the In-car/Repeater or they can choose to use external power source by using power cable which is provided in the FOBO Ultra packaging box. It is recommended to use In-car /Repeater with external power source.

Total number of axles:

In-car unit – Current permissible maximum axles per in-car unit are 6 axles (22 sensors). Front axle with 2 sensors and rest 5 axles with 4 sensors.

Repeater unit - Current permissible maximum axles per Repeater unit are 6 axles (24 sensors). Each axle with 4 sensors.

Disclaimer: For constantly moving vehicles users must use direct power supply from the vehicle (By using the power cable provided in the package) to power the In-Car/Repeater unit to ensure uninterrupted operation of such units. The battery power supply (5 pieces of AAs) is meant for pairing and occasional stand-alone operations. New 5 AA batteries are estimated to last up to 550 hours of continuous operation. **After setting up the system using 5AA batteries, remove them upon connection with external power supply to avoid depleted batteries leak and subsequent internal corrosion.**

4.2 Tire Sensor Unit

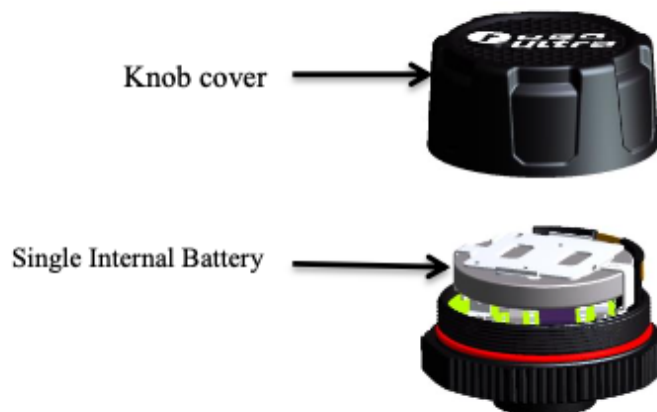

Knob Cover	Waterproof cover. Please ensure the red silicon ring is intact to prevent water from getting into electronics compartment.
Single Internal Battery	CR2032 coin cell battery. When replacing battery, please ensure the “+” sign of the battery is facing up away from PCB.
Internal PCB	Internal electronics circuit (The pressure sensor chip is mounted within this PCBA, and it senses the tire pressure against a built-in vacuum, resulting in an Absolute Pressure reading. The internal firmware will then subtract the sea-level pressure of 101.3 Kpa (14.7 psi) from this reading.

	<p>This final reading which will be shown in the App can be termed as i) Tire Absolute Pressure minus sea level pressure, or ii) Gage Pressure reference to sea-level altitude. With this formulation, FOBO Ultra sensor will read the same pressure value for any given time, irrespective of altitude (assuming a constant temperature). This will ensure the correct tire footprint per vehicle manufacturer's pressure recommendation, for all altitude above sea-level, given a constant temperature.</p> <p>As a corollary, a tire with a FOBO reading of, say 40 psi at an altitude of 5000ft, will read the same 40 psi when driven to sea-level, given a constant temperature. In reality, it will read higher due to the warmer temperature at sea-level, and may need some air release if the temperature difference is great. Tire pressure generally will increase 1 psi (~7kPa) for every 10 deg F (5.6 deg C) rise in temperature.</p> <p>FOBO wishes to highlight the above formulation is for usage at sea-level and above, and will not be accurate for use otherwise. In practice, this should not be an issue as the lowest area on earth will result in an insignificant error of 0.3 psi (~2 Kpa).</p> <p>For users who wish to retain 'Gage Pressure Reading', the FOBO Ultra 2 App has a Gage Pressure, adjusted to local altitude using cell towers or individual phone barometer if available. This Gage Pressure button can be accessed from the App.</p>
--	--------------------------------------------------------------------------------------------------------------------------------------------------------------------------------------------------------------------------------------------------------------------------------------------------------------------------------------------------------------------------------------------------------------------------------------------------------------------------------------------------------------------------------------------------------------------------------------------------------------------------------------------------------------------------------------------------------------------------------------------------------------------------------------------------------------------------------------------------------------------------------------------------------------------------------------------------------------------------------------------------------------------------------------------------------------------------------------------------------------------------------------------------------------------------------------------------------------------------------------------------------------------------------------------------------------------------------------------------------------------------------------------------------------------------------------------------------------------------------------

FOBO Ultra sensor units are designed to be robust and operate reliably 24x7 to provide tire information around the clock. It is designed to be water proof and by our special use of custom engineering plastics, it will be able to withstand road salts or other common automotive chemicals (petrol, engine oil, wash shampoo, etc.).

Our designers have designed the sensors to ensure that there is no air leakage as it replaces the tire's original valve cap. There is no need to screw on the sensor extremely tight. Apply a reasonable hand twist force to ensure the sensor is securely installed and should be able to be removed by hand with ease.

When installing the sensors, please follow the on-screen prompt of the In-car unit. After installation, in the event the tire sensors positions are mixed up, usually after performing a tire rotation maintenance, you can easily reposition the sensors to their correct position by selecting 'Sensor Rotation' on the in-car unit and follow the on-screen instructions. This eliminates the need to remove the tire sensors physically.

A missing or damaged tire sensor can be replaced easily through the In-car unit/Repeater. You will need to purchase a replacement sensor which you can do so online at www.my-fobo.com. To replace the sensor, first select 'Disable Sensor' on the In-car/Repeater unit under sensor Management system and the pop-up will prompt you to tap on the tire position that you want to disable. Then, select 'Replace Sensor', upon selecting the default image on In-car/Repeater unit will blink at the first disabled position, follow the on-screen instruction and the replacement sensor will be paired and be ready to use.

FOBO Ultra Sensor Dimensions in mm:

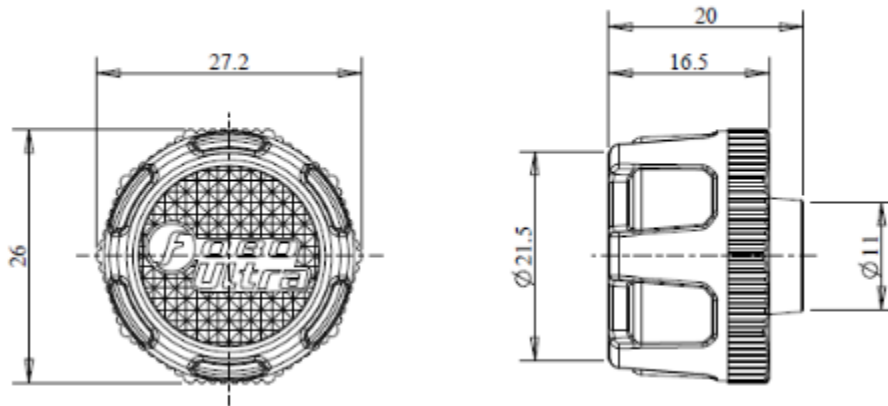

NOTE: Battery life span up to Twelve months is an estimate based on normal use at 23 °C. Battery life may vary according to usage and climatic temperature.

Battery life span will change due to the following reasons:

- 1) Frequent change of pressure threshold setting in the App.
- 2) Disabling & enabling of sensors.
- 3) Release & pairing.
- 4) Removal & screw-on of sensors.
- 5) Operating under extreme cold/hot temperature.
- 6) Testing of product.
- 7) Rotation
- 8) Trigger alert or let activated alerts unattended.
- 9) Multiple removal and screw-on of sensors for equalizing all tire pressures.

All these activities will drain a battery very fast and affect the battery life span.

4.3 Extension Valve & Screw-On T-Valve

Extension Valves are helpful when inflating wheels fitted with short or difficult to reach tire valves. Extension valve is suitable for inner tire valve stem in axles with 4 wheels. The ends of these extensions are easily accessible with plenty of clearance.

Step by step pictures to use Extension Valve & Screw on T-valve

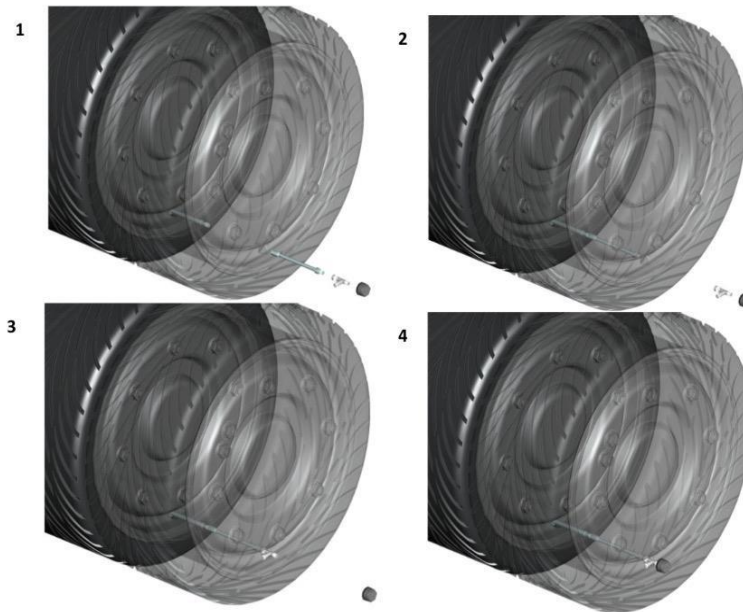

Screw on T-valve and Extension valve Dimensions:

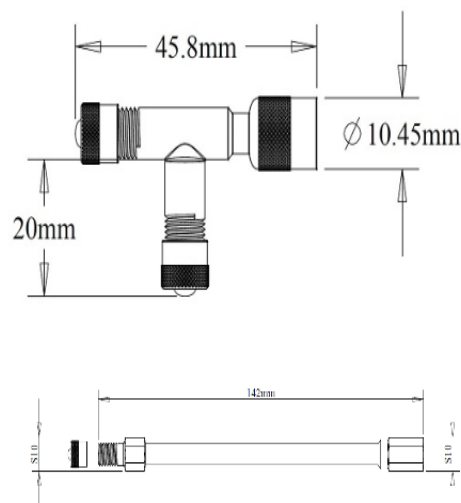

To purchase Extension Valve & Screw-on T-Valve you can visit our website www.my-fobo.com

4.4 In-Car Unit Mounting and Proposed Location

It is advisable to mount the In-Car unit at the proposed location in the cab for better signal reception. This proposed in-car unit location will ensure the maximum signal reception from all the sensors. Refer to the illustration below showing mounting and proposed location:

IN-CAR FIXING METHOD AND PROPOSE AREA (LEFT SIDE DRIVER)



VELCRO HOOK

STEP 2- ADHERE VELCRO HOOK ONTO FRONT LEFT PILLAR (PROPOSE LOCATION)

VELCRO LOOP

STEP 1- ADHERE VELCRO LOOP ONTO IN-CAR BACK SIDE. (WITHIN RECESS AREA)

IN-CAR



IN-CAR FIXING METHOD AND PROPOSE AREA (RIGHT SIDE DRIVER)

IN-CAR



VELCRO LOOP

STEP 1- ADHERE VELCRO LOOP ONTO IN-CAR BACK SIDE. (WITHIN RECESS AREA)



VELCRO HOOK

STEP 2- ADHERE VELCRO HOOK ONTO FRONT RIGHT PILLAR (PROPOSE LOCATION)



4.5 Repeater Mounting and Proposed Location

Refer to the illustration below, showing repeater mounting and proposed location:

Step 1:

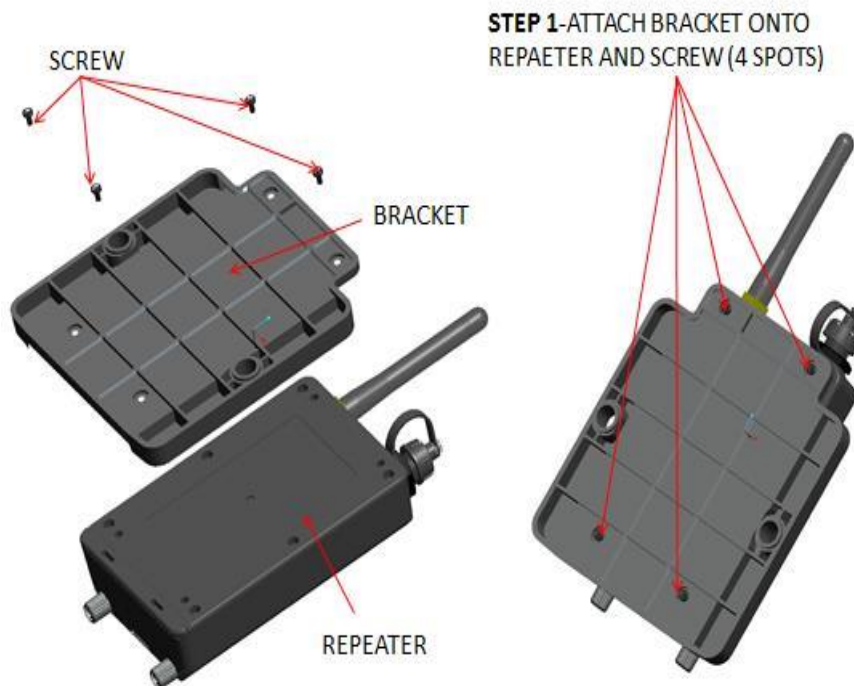

Step 2 & 3:

STEP 2- FIND FIXING LOCATION WHICH IS EASY TO FIX. PROPOSE TO FIX THE REPEATER ONTO TRAILER HORIZONTAL BAR WHICH LOCATED JUST AFTER THE GROUP OF REAR TIRES.



STEP 3- DRILL 2 HOLES AS BELOW DIMENSIONS

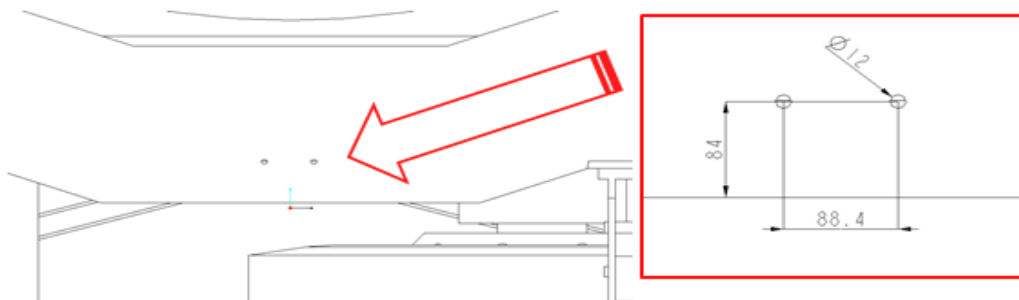

Step 4:

STEP 4- ATTACH THE REPEATER UNIT ONTO HORIZONTAL BAR AND FIX BY 2 M8 BOLTS AND 2 M8 NUTS. MAKE SURE THE ANTENNA IS FACING DOWNSIDE.

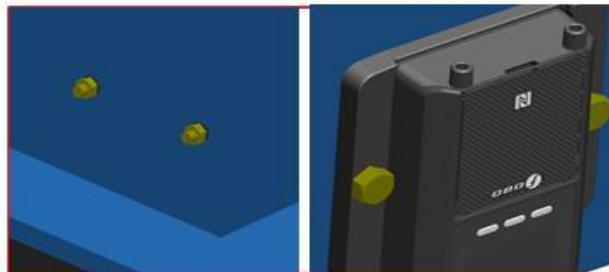

5 Using FOBO Ultra

5.1 Description of FOBO Ultra 2 App

5.1.1 Login Page



Email Login – A generic login option with email and password. Please use a valid e-mail address.

Google, Facebook, Apple Logins – Login options using your Google, Facebook or Apple ID. If you use Apple ID, please don't hide your email address. Your FOBO account and vehicle profile information will be referenced to your email address.

Forgot Password – To retrieve a lost password, provided you still remember your email address.

Create New Account – To open the account creation page.

5.1.2 App Permission Requests

During login, the app will request the following permissions:

Bluetooth Notification (iOS only), Storage (Android only) and Location. Please enable/allow them to ensure all App features work properly.

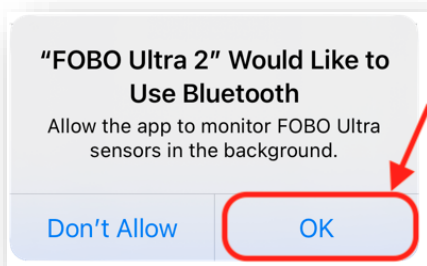

Bluetooth Permission (For iOS) – This permission is required to let the FOBO Ultra 2 App monitor in-car, repeater and sensor in the background.

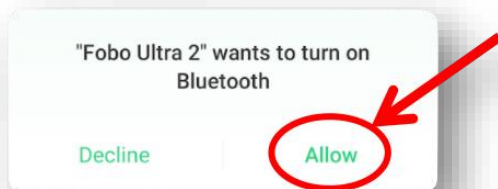

Bluetooth Permission (For Android) - In Android, although won't have any Bluetooth permission need granted by user, but the app required the user to switch on the Bluetooth if detect Bluetooth is off.

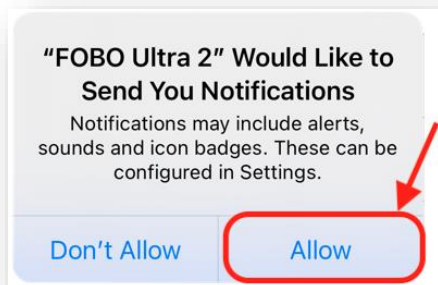

Notification Permission (For iOS) – This permission is required to let the app receive pressure alert and other notifications.

Location Service Permission (For iOS): Allow location access for FOBO Ultra 2 App to Always, this is required for background monitoring.

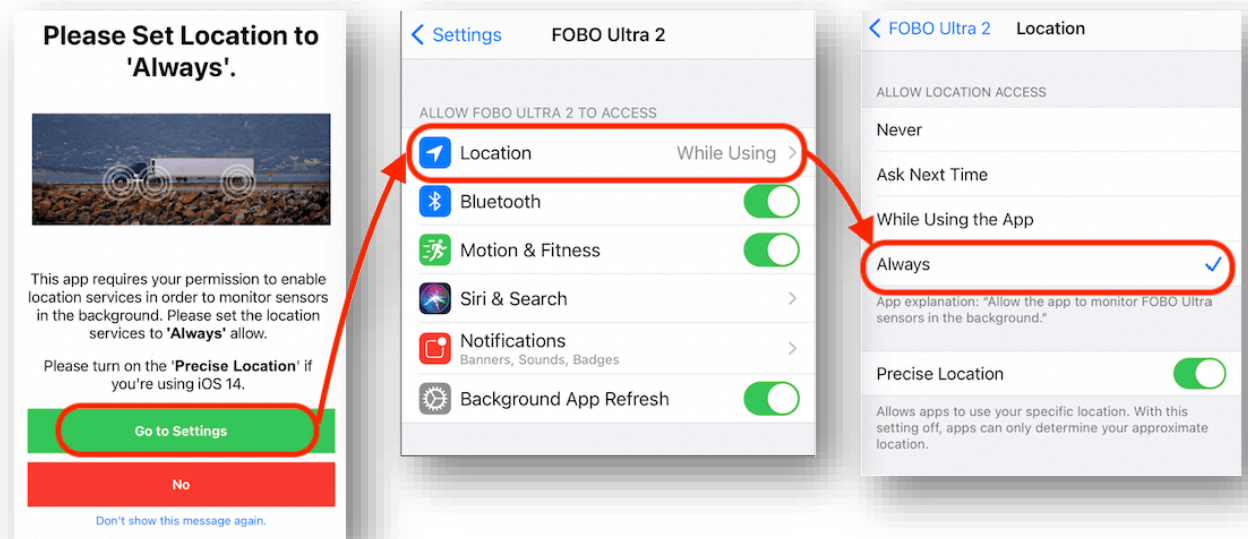

Location Service Permission (For Android) – This permission is required to let the app determine its proximity to in-car, repeater and sensor. In Android, you must turn on the Location services. If your device is below Android 9, you must change the location mode to “High Accuracy”. If the app detects the user location mode not high Accuracy, the permission will request you change the location mode to “High Accuracy”.

In Android 10 and above, you must change the Location Access to “Allow all the Time”. If not, you won’t get the latest data when the app is in background.

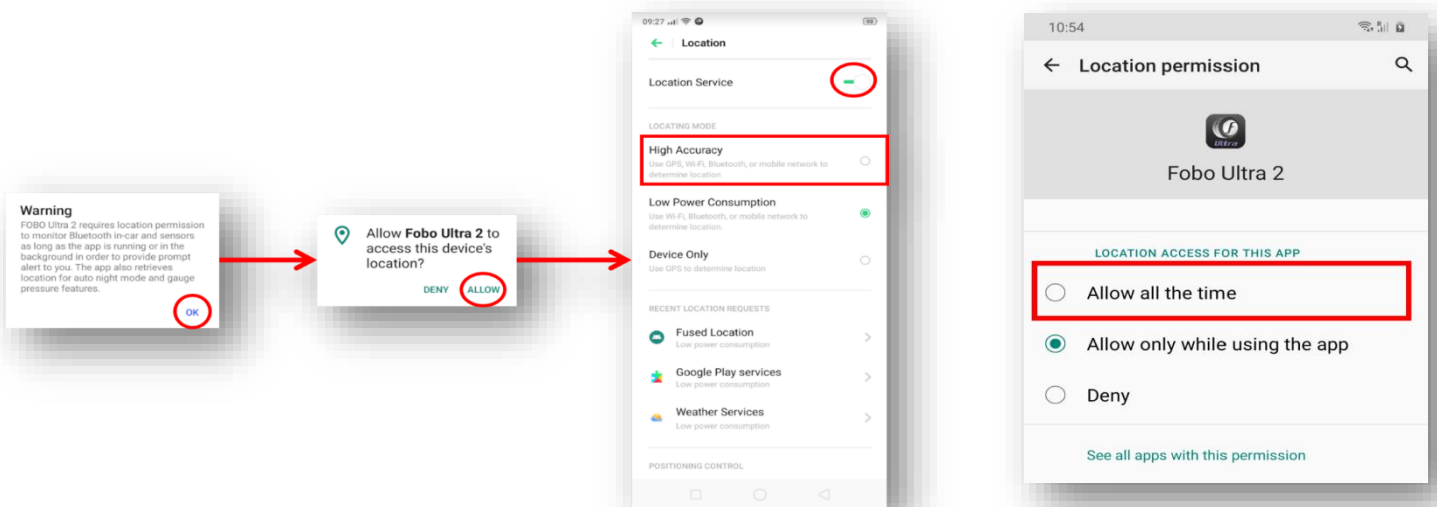

Storage Permission (For Android) – This permission is required to let the app store data to internal storage.

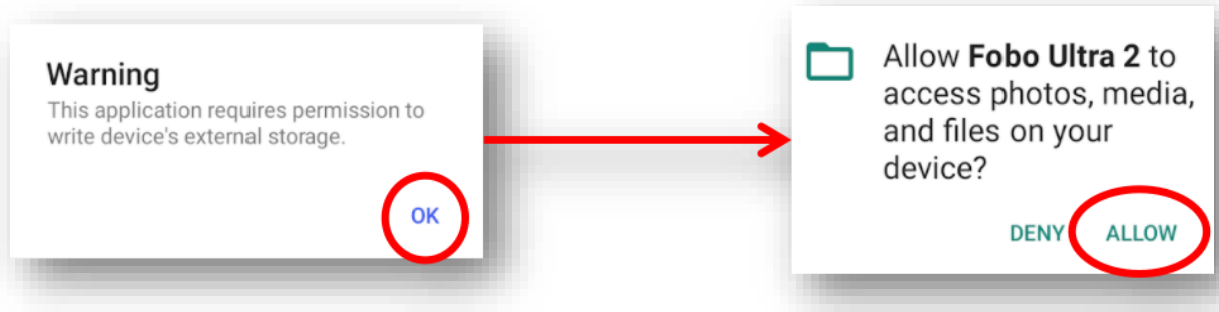

5.1.3 Home Page

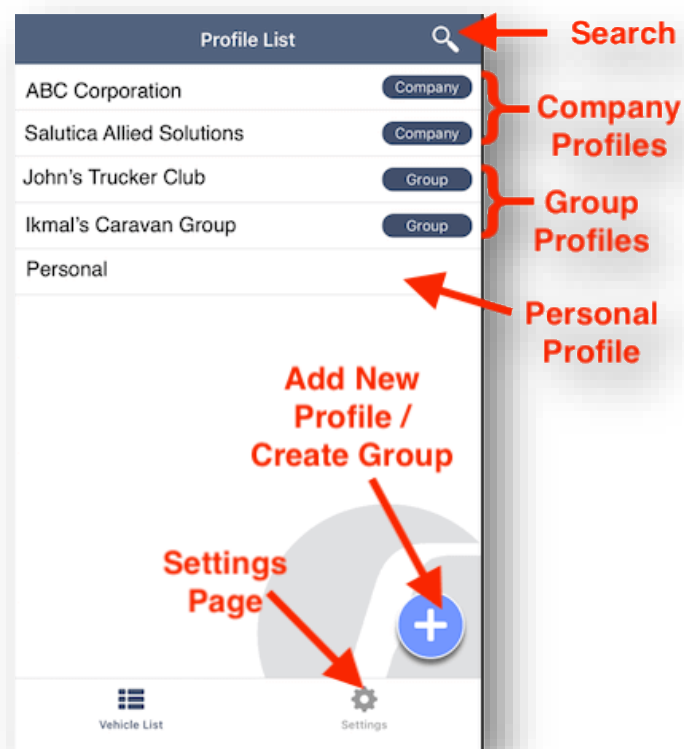

The profile list is divided into three types namely **Personal**, **Group** and **Company**.

Add New Profile / Create Group – Pressing the ‘Plus’ button will allow you to add a Personal profile by bringing you to in-car/repeater installation page. Additionally, it will also give you an option to create a Group.

Settings Page – This will open the General Settings page.

Search – Pressing this search button will allow you to search for a specific profile according to keyword that you have entered. Useful when you have many profiles.

5.1.4 Installation page

To install an In-car or a Repeater, press the '+' button and then click on 'Install In-Car/Repeater' option. Follow the instruction as displayed on the App screen.

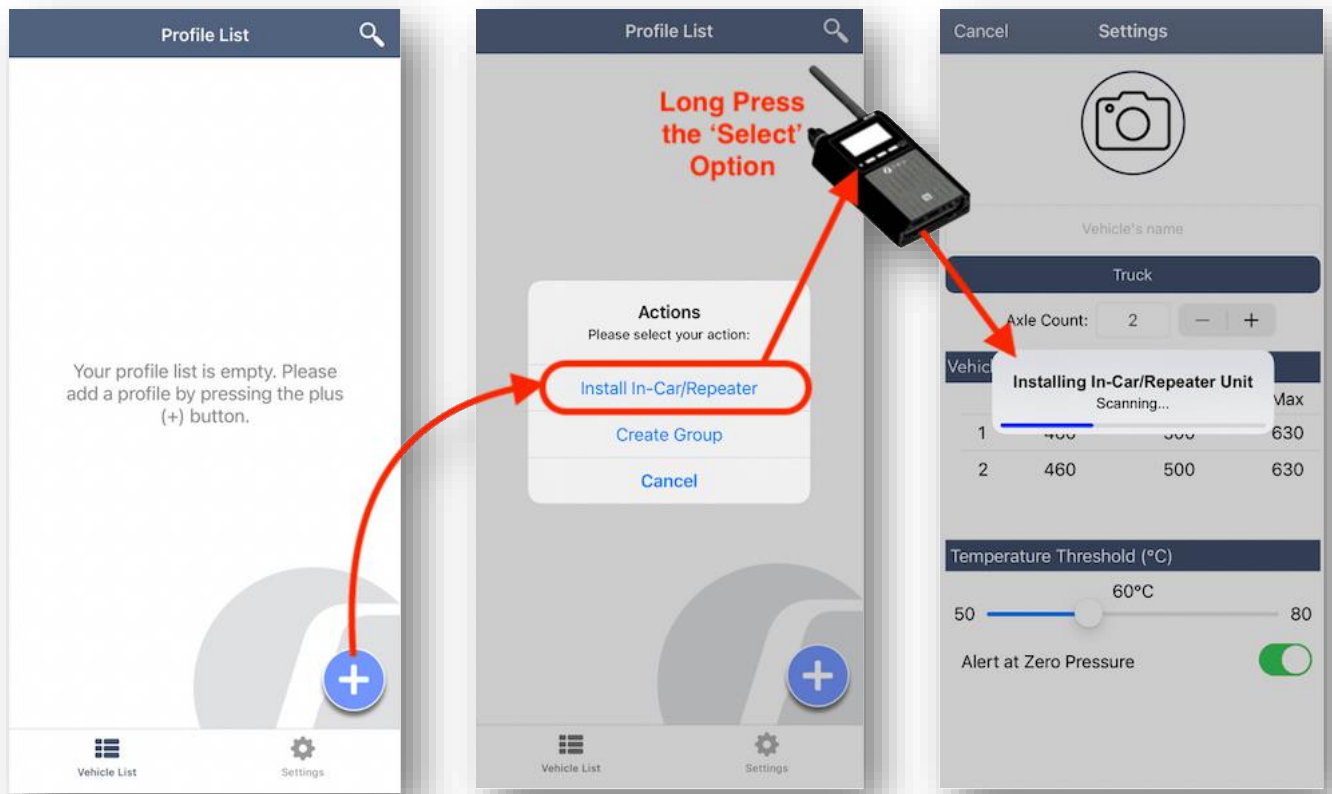

5.1.5 Vehicle Settings Page

This page allows you to change info related to your profile and vehicle settings. You can access this page after saving a profile as shown in section 5.1.4.



Cancel – Pressing this button will bring you back to the vehicle details page. When you first install an in-car or a repeater, the ‘Cancel’ button will be disabled until you fill in all the required information and press ‘Save’.

Save – Pressing this button will save your settings to the server and the app will attempt to connect to an in-car or a repeater to perform a sync process to update any changes that you have made. Please ensure you have a stable Internet connection and your phone is near to in-car / repeater unit when performing this action.

Profile Photo – Pressing this button will allow you to select a photo from your phone gallery or capture a photo from your phone camera to be used as a profile photo. Please ensure your photo file size is less than 2.0 mb.

In-Car ID (Airpair) – Representing your unique in-car / repeater ID, also known as ‘Airpair’.

Profile Name – Representing your profile name. It is limited to 10 characters (a-zA-Z0-9). This name will also be displayed in your in-car / repeater unit’s screen.

Vehicle Type – Representing your vehicle type, e.g. Truck, RV, Trailer. You can only modify this once during in-car / repeater installation. If you wish to change vehicle type, you need to release the whole set and install back from scratch.

Axle Count – Representing your vehicle axle’s count. You can only modify this once during in-car / repeater installation. If you wish to change number of axles, you need to release the whole set and install back from scratch.

Pre-set Settings – Allow you to save and load pre-set pressure settings. You can add multiple pre-set pressure threshold profiles; next time just hit the drop-down icon and choose desired pre-set profile and your pressure settings will be changed.

Pressure Settings – Allow you to set Min/Rec/Max pressure thresholds.

Temperature Threshold – Allow you to set temperature threshold.

Alert at Zero Pressure – Allow you to receive alert when a pressure reaches zero.

5.1.6 Vehicle Details Page

The image below showing two vehicle details pages named as ‘Johnny’s Truck’ and ‘Trailer’.

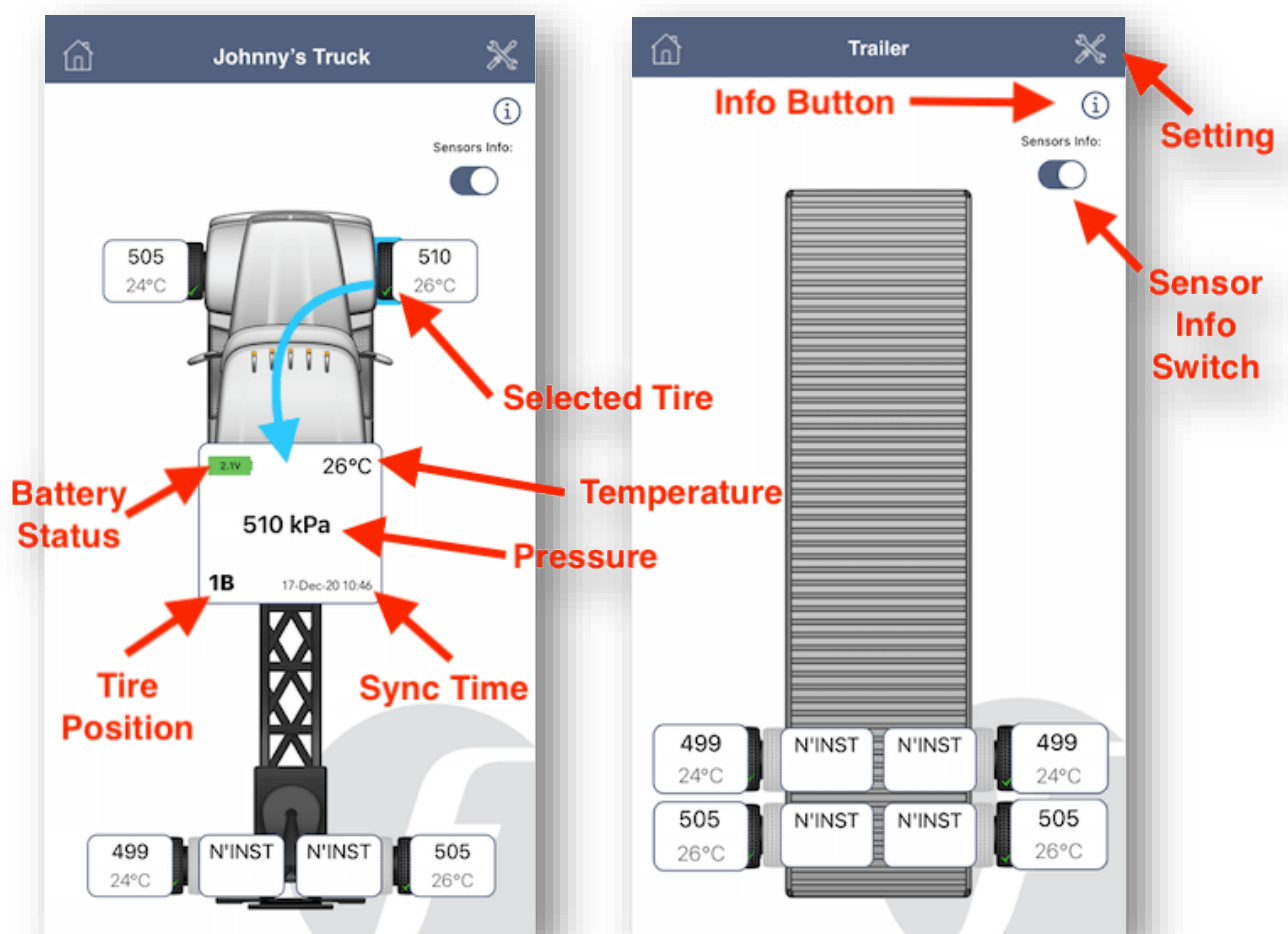

Pressure – Display pressure reading in selected pressure unit, such as; kPa, psi, bar or ksc unit (set in General Settings page). If the pressure exceed/reduce the maximum/minimum setting, the colour will turn red.

Temperature - Display temperature reading in selected temperature unit, such as; Celsius or Fahrenheit unit (set in General Settings page).

Battery Status – Display a sensor battery status. The status will turn red if the battery level is low.

Sync Time – Display a sensor last sync time with the app. The app will sync automatically with in-car if it is within range.

Tire Position – Display a tire position.

Selected Tire – A selected tire will be highlighted in blue colour.

Sensor Info Switch – Flipping this switch on/off will hide or unhide the sensor info box.

Setting – This button will open the setting page.

Info Button – Pressing this button will open an information page to get details of what each colour tire represents as seen below.

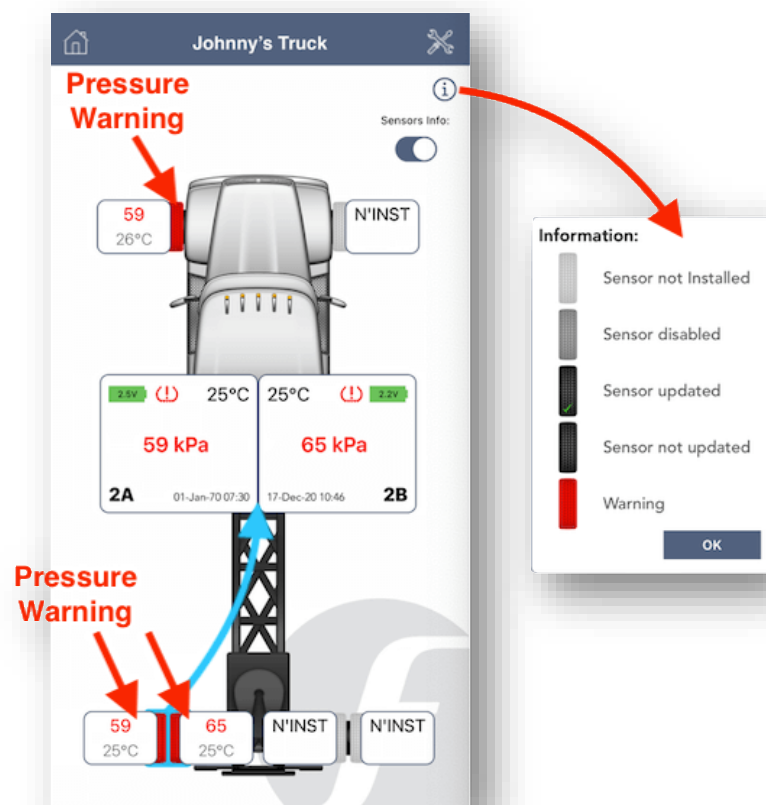

The image above shows a vehicle details page showing a vehicle having a pressure warning (low pressure).

5.1.7 General Settings Page

This is a general settings page. These settings control the overall global configuration of all settings within the app.



User Email – Display your email address that you use to login into the profile.

Pressure Unit – Allow you to choose your preferred pressure unit.

Temperature Unit – Allow you to choose your preferred temperature unit.

Alarm Tone – Allow you to choose your preferred alarm tone.

Keep Screen On – Turning On this feature will prevent the app from turning off the screen or go to the ‘Sleep’ state when the vehicle details page is open.

Auto Night Mode – Turning On this feature will change the overall app appearance to a ‘Dark Mode’ when it detects that it is a night time.

User Guide – Turning On this feature will make the app to display an installation guide during in-car, repeater and sensor installation to help you with your action.

Clear Log – Pressing this button will clear all the recorded logs (sensor log, beacon log, document log, etc.) from your app.

Feedback – Pressing this button will allow you to send feedback and log files to FOBO customer service. If you wish to view your log files, change the recipient email address to your email.

Terms and Conditions – Pressing this button will open the ‘Terms and Conditions’ page.

Privacy Policy – Pressing this button will open the ‘Privacy Policy’ page.

User Manual Guide – Pressing this button will open the ‘User Manual Guide’ page.

Visit FOBO Website – Pressing this button will open the FOBO website.

Logout – Pressing this button will log you out from your current profile. This action requires an Internet connection.

5.1.8 Profile List Page

Company Feature

A company profile list page (Refer to App image under section 5.1.3) from ‘Salutica Allied Solutions’.

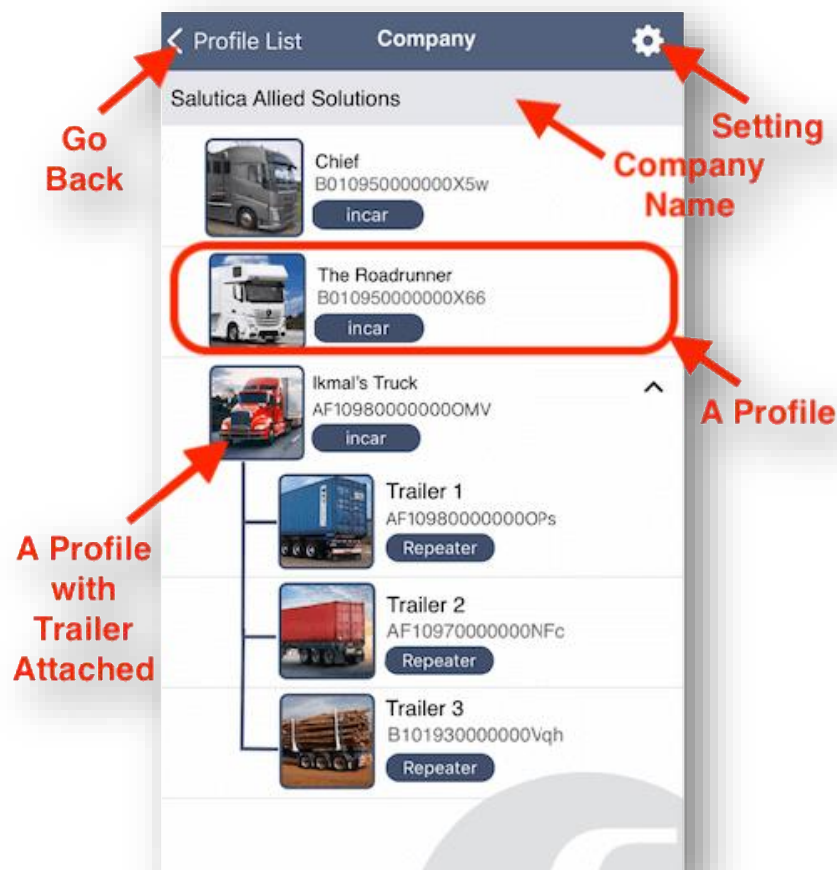

Company Name –For a Company profile, it will display a company name. For a Group profile, it will display a group name. For a Personal profile, it will display ‘Personal’.

Setting – Pressing this button will open the Setting page.

Go Back – Pressing this button will close the current page and go back to the Home page.

A Profile – This is a vehicle profile which displays photo, name, device ID (Airpair), and device type (InCar or repeater). Pressing the profile will open the Vehicle Details page.

A Profile with Trailer Attached – A profile can have sub profile(s) attached underneath it. The sub profile typically consists of trailer(s). A sub profile is also referred to as a ‘hook’.

Group Feature –

This feature allows authorized person to create a group with selected vehicles from his vehicles list and then add selected members to that group by sending them an invitation. Multiple groups creation is allowed.

Example - A group profile list page from ‘Amir’s Trucker Group’.



Setting – Pressing this button will open the group setting page as shown in the right image.

Group Name – The name of the group. Only the group owner can modify the group name.

Group Description – The description of the group typically describing the group activities. Only the group owner can modify the group description.

Group Creation Date – Representing the date and time the group was created.

Member List – Representing a list of members that have joined the group.

Member's Vehicle List – Representing a list of vehicles belonged to the group members.

Invite Member / Add Vehicle – Pressing the 'Plus' button will give you two options: (i) invite a member to join your group (if you are a group owner), (ii) add your vehicle into the vehicle list (if you haven't added a vehicle before).

Leave Group (Member) – Pressing this button will cause you to be removed from the group. A confirmation dialog will be shown first prior to your removal as a preventive measure for user from unintentionally pressing this button.

Delete Group (Group Owner) – Pressing this button will cause the group to be deleted. Please note that you cannot delete a group if the group still have member(s). The member list must be emptied first prior to performing this action.

5.2 Installing FOBO Ultra 2 App

You are required to have a smartphone with Bluetooth 4.0 (Bluetooth Smart) capability in order to use FOBO Ultra. The smartphone must also be running on iOS 12.0 or Android 5.0 and above. Follow the steps below to install your FOBO Ultra:

Download the FOBO Ultra 2 App onto your smartphone:

1. For iPhone users, download from Apple's AppStore. For Android users, download from Google Play. Search for 'FOBO Ultra 2'.
2. Launch FOBO Ultra 2 App and key in your email address or choose from other login methods available.
3. You will be brought to the App's Home screen.

Note: -

- 1 An activation e-mail message will be sent to your e-mail address when you create a new account and click on "Create" under the login page.
- 2 If you do not receive this activation e-mail from FOBO Admin, please check your e-mail address entry to ensure it is valid without typo error.
- 3 This e-mail may also be filtered by some e-mail servers. Please check your Spam mailbox.
- 4 If you still do not receive any message from FOBO Admin after 15 minutes (with a good Internet connection), please write in to fobo@salutica.com.my with your sign-in email.

IMPORTANT:

The email activation is to ensure that your account signup is done securely. FOBO Ultra is locked to your FOBO account as an anti-theft deterrent. Stolen sensors cannot be used by anyone else other than the FOBO account owner.

Location service is required to be enabled for the FOBO Ultra 2 App. The location service on the iOS/Android system has other functionality that the FOBO Ultra 2 App uses to operate properly and to sync with the In-Car unit. It will ensure FOBO Ultra functions as designed, mainly for alert functions, and also the gauge pressure feature as required by users living at high altitudes. FOBO Ultra is designed to be a low energy system and does not drain your smartphone battery excessively.

By submitting your information to sign up a new user account, you acknowledge your acceptance to the terms and conditions of our Software Licensing Agreement and Privacy Policy.

5.3 Installing FOBO Ultra In-Car Unit / Repeater & Sensors

TO REDUCE THE RISK OF AN ELECTROSTATIC DISCHARGE (ESD) PLEASE TOUCH THE WHEEL WHEN SCREWING ON THE TIRE SENSOR ON TO THE TIRE VALVE. THIS IS TO MINIMIZE POTENTIAL ESD ATTACK WHICH MAY CAUSE DAMAGE TO THE TIRE SENSOR AND ITS FUNCTION.

INSTALLING FOBO ULTRA SETS ON MORE THAN ONE VEHICLE WHICH ARE PARKED CLOSELY TOGETHER MAY CAUSE CROSS INTERFERENCE TO THE



BLUETOOTH SIGNALS. PLEASE INSTALL FOBO ULTRA ON ONE VEHICLE AT A TIME.

To begin using FOBO Ultra, firstly ensure that the FOBO Ultra 2 App is downloaded and you have already login to the App (Refer to section 5.2).

Follow the steps below to pair FOBO Ultra to your smartphone: -

- 1) Turn on your smartphone's Bluetooth connection.
- 2) Open FOBO Ultra 2 App.
- 3) Open the battery cover and remove the battery tab to power up the In-Car/Repeater unit.
- 4) Set the FOBO Ultra's In-Car unit/Repeater into 'Pairing Mode' by long press "SELECT" to start pairing.
- 5) Click on "+" button to create profile and to start pairing (Refer to section 5.1.4). Upon successful pairing with In-Car unit, an 'Airpair ID' will appear on the smartphone in the Airpair box.
- 6) Key in the name you would like to identify your Vehicle.
- 7) Choose number of Axles.
- 8) Tap on the profile picture box and take a picture of your vehicle.
- 9) Select the vehicle manufacturer recommended tire pressure for all the axles (choose number of axles). The information is usually available on a sticker at the door jamb (side of the driver's door) or in the owner's manual. For certain vehicle models, the information sticker may be on the trunk lid or on the fuel door. You cannot proceed with the pairing without the input of this information into the FOBO Ultra 2 App.
- 10) Click 'Save' on the top right corner of the screen.
- 11) Upon successfully creating the profile on smartphone, select 'Installation' under Main Menu of In-Car unit and follow the instructions on screen of the In-Car unit.
- 12) You will be prompted that installation is completed and you are now ready to use FOBO Ultra.



CAUTION:

Motor vehicles of all kinds (Caravan, RV and Trucks) come with a very wide variety of rims, wheels, and tires, with an even larger choice of aftermarket products. It is impossible for us to test every combination and check the fitment of the FOBO Ultra sensor. In some instances, when the FOBO sensor is screwed onto the valve stem, it might extend slightly beyond the face of the rim/wheel. If the rim/wheel comes close to or strikes an object, such as a curb, a pothole, the guide rail for an automatic vehicle wash, or a component on the vehicle, the FOBO sensor or the valve stem itself might become damaged. This can cause the FOBO to provide improper readings, or might cause a loss of air pressure. We recommend that you carefully assess the fitment of your rims, wheels, tires and the FOBO on your vehicle. If you have any concerns, consult with your tire shop or auto mechanic.

5.4 Sensor Rotation

It is good practice to rotate your tire positions regularly to balance the thread wear of your tires, usually swapping the front tires with the rear tires. FOBO Ultra is designed to conveniently set the sensors to their correct tire position in the in-car unit after you have swapped your tires on your vehicle. You do not need to physically remove the sensors. To correct the position of the sensors in the in-car unit/Repeater, please select “Tire Rotation” under Main Menu on in-car unit/Repeater. You will be prompted by the in-car unit/Repeater to:

- 1) Select the sensor position to rotate. Move to the desired position to select the sensor by using the arrow key which is in the middle of the in- car unit/Repeater.
- 2) Upon selection, you will be prompted to touch the sensor at the in-car unit /Repeater NFC location (the symbol “N”)
- 3) There will be a message to indicate successful registration of new position.
- 4) Choose NEXT to go to another tire position to rotate.
- 5) Choose END to complete the rotation process.

You are now ready to use FOBO Ultra with the new tire positions. You can perform tire rotation as often as you want.

5.5 Disable Sensor and Replace New Sensor

You may want to disable a sensor due to a missing sensor or damaged sensor or to install a replacement sensor. Disabling a missing or damaged sensor will remove future missing sensor alerts.

To disable a tire sensor: -

- 1) Go to Sensor Management in the Menu of In-Car/Repeater, select “Disable sensor”.
- 2) Select the tire position in the screen to disable.
- 3) Once disabled You will see “Sensor Disabled” message will appear on the screen. Take note that FOBO Ultra will stop monitoring the disabled sensor position.

To install a replacement tire sensor: -

1. Select “Replace sensor” under Sensor Management in the Menu of In- Car/Repeater.
2. Move to the desired position to assign a replacement sensor.
3. Select the tire position to replace.
4. You will be prompted to touch the sensor to the in-car unit.
5. Once replaced you will see “Sensor is successfully replaced...” Please mount the sensor to the physical tire position in accord with the screen message.

NOTE: You can only install a replacement sensor after the tire position has been “Disabled”. You can purchase replacement sensors online from www.my-fobo.com.

5.6 Release (Total/Sensor)

Release Total System:

Before passing on your FOBO Ultra set to another user, you will have to release the Total system from your FOBO account. Select “Release (Total/ sensor)” under Main Menu on in-car unit then “Release total system”.

Make sure your In-Car unit and smartphone are with you. You will be prompted with a message to “Select PROCEED to continue and concurrently, on the smartphone you need to long-press onto the profile that you want to release and follow the instruction on the phone App”. Upon selecting PROCEED the In-Car unit will connect to the smartphone to initiate the release process. You will hear an audible sound upon successful release and a “System Released” message will appear on in-car unit screen.

Do note that after you have done “Release Total System” the sensors are still paired to the InCar unit. To release all the paired sensors, you need to follow the “Release Sensor” section below.

Note: Return InCar unit or Repeater unit together with all the sensors have to be released from the mobile app in order to claim for warranty.

Release Sensor:

You may want to release paired sensors prior to passing the sensors to another user or return the sensors for replacement purpose. Select “Release (Total/sensor)” under Main Menu on in-car unit and then select “Release sensor”. Follow the steps as indicated by the InCar unit.

Note: Return sensors have to be released in order to claim for warranty.

5.7 Tire Inflation/Deflation

To Inflate/Deflate the tire user just need to unscrew the sensor, inflate/deflate the tire then screw back the sensor on tire valve. Users do not need to release or disable the sensor.

5.8 Drop & Hook

FOBO Ultra System offers Drop & Hook for easy attachment to and detachment from the trailers of prime mover. It enables harvesting of sensor data by clusters of individual sensors and then transmits the data amongst inter-connected cluster to the In-Car unit. FOBO Ultra system can display up to 94-wheel positions with a combination of 1 In-Car + 3 Repeater cluster. **For example:** for a prime mover that hauls 1 trailer, FOBO Ultra allows 1 In-Car unit for the prime mover and 1 repeater unit for the Trailer. 1 In-Car unit can monitor up to a cluster of 22 sensors while Repeater unit can monitor up to a cluster of 24 sensors. Each Repeater unit can be independently controlled, programmed and monitored.

To HOOK a trailer:

1. Select “Drop & Hook” in the Main Menu of In-Car unit.
2. Select “Hook a trailer”.
3. Upon selecting, the in-car unit will scan for available trailers nearby in Bluetooth range.
4. List of available trailers will be displayed on the in-car unit screen.
5. Select the desired trailer from the list which you would like to Hook.
6. To confirm press “Yes”.
7. Once hooked you will see “Hook successful” message will appear on the screen.

To DROP a trailer:

1. Select “Drop & Hook” in the Main Menu of In-Car unit.
2. Select “Drop a trailer”.
3. List of hooked trailers will be displayed on the screen.
4. Select the desired trailer from the list which you would like to Drop.
5. To confirm press “Yes”.
6. Once dropped you will see “Drop successful” message will appear on the screen.

Note: To Drop a Trailer it’s not necessary for the repeater to be available. User can drop a trailer using in-car unit.

5.9 FOBO Portal

FOBO Portal is a centralized FOBO products management and data visualization page where users manage their logged-in devices and installed FOBO products on the go, on the cloud. Currently, FOBO portal only supports FOBO Ultra 2 at launch with limited features and is expected to add support for other products over time.

Portal link- <https://portal.fobocloud.com/>

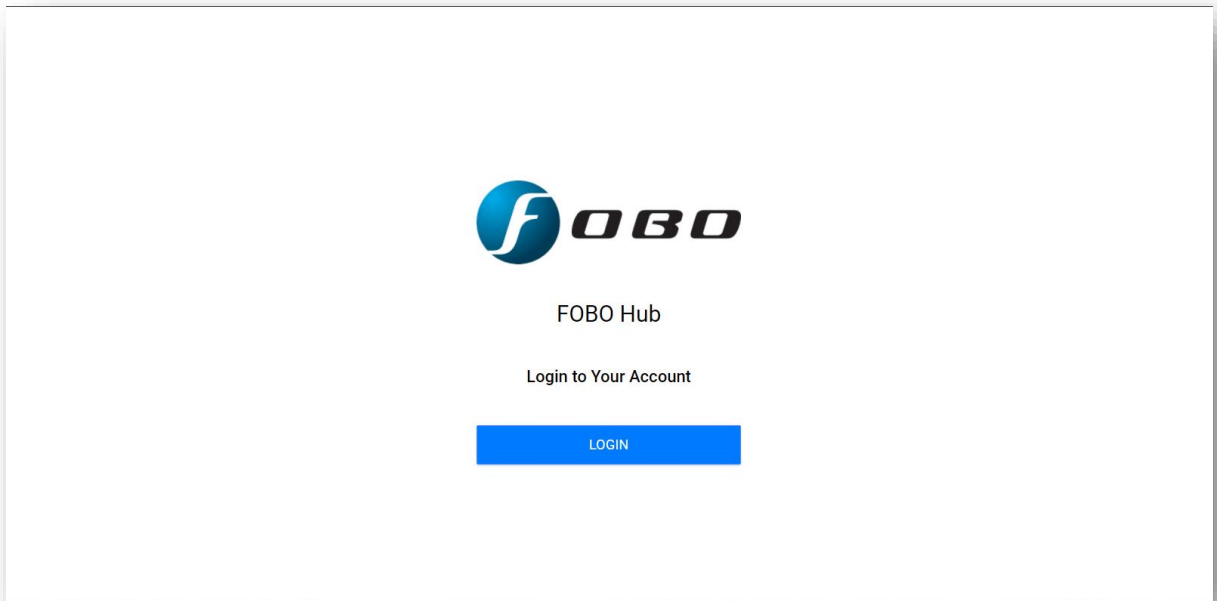

(Picture illustrated the main page. When user clicks on the login button on the page, it will proceed to redirect user to the login page.)

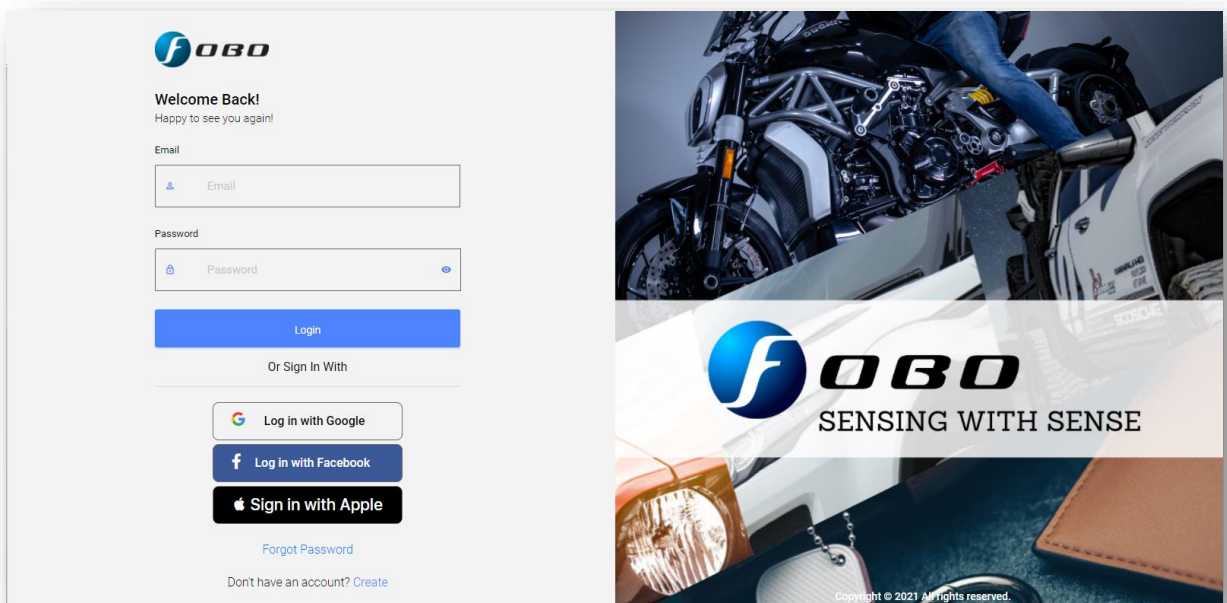

(User can login to the portal using the same login with the FOBO Ultra 2 applications. Furthermore, user also can opt for two-factor authentication (2FA) with their account to add another layer of security to their account.)

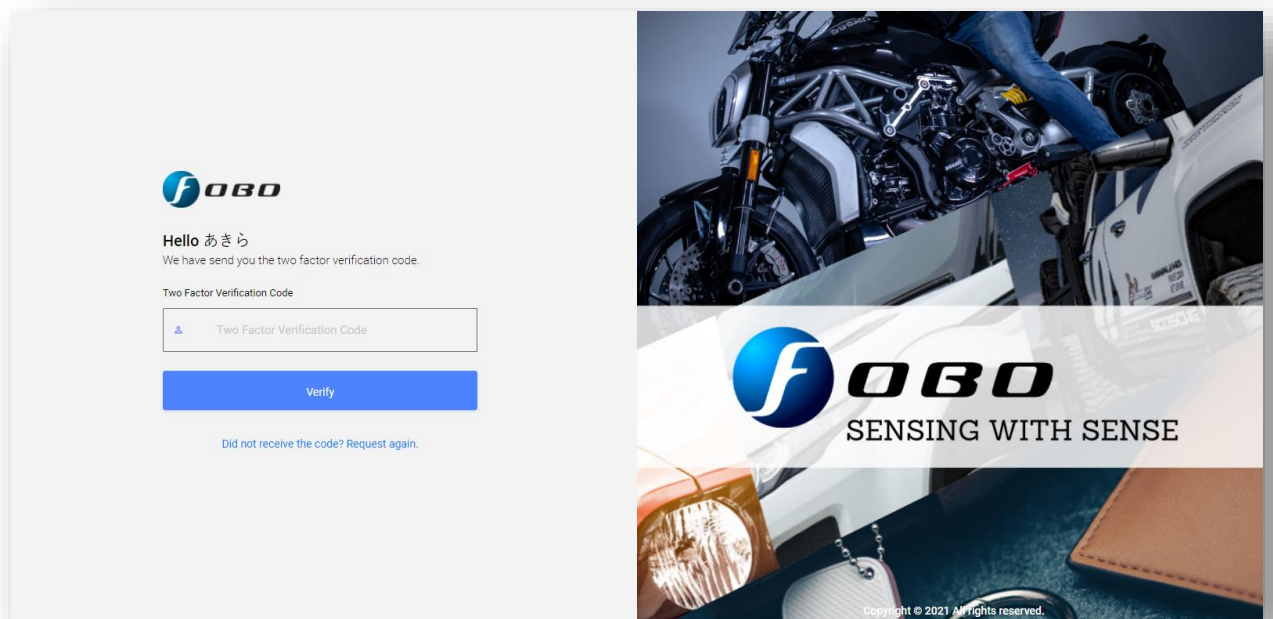

(Picture illustrate the 2FA challenge page. An email containing the 2FA code will be send to user. User can also request again to send 2FA code if the first one did not arrive.)

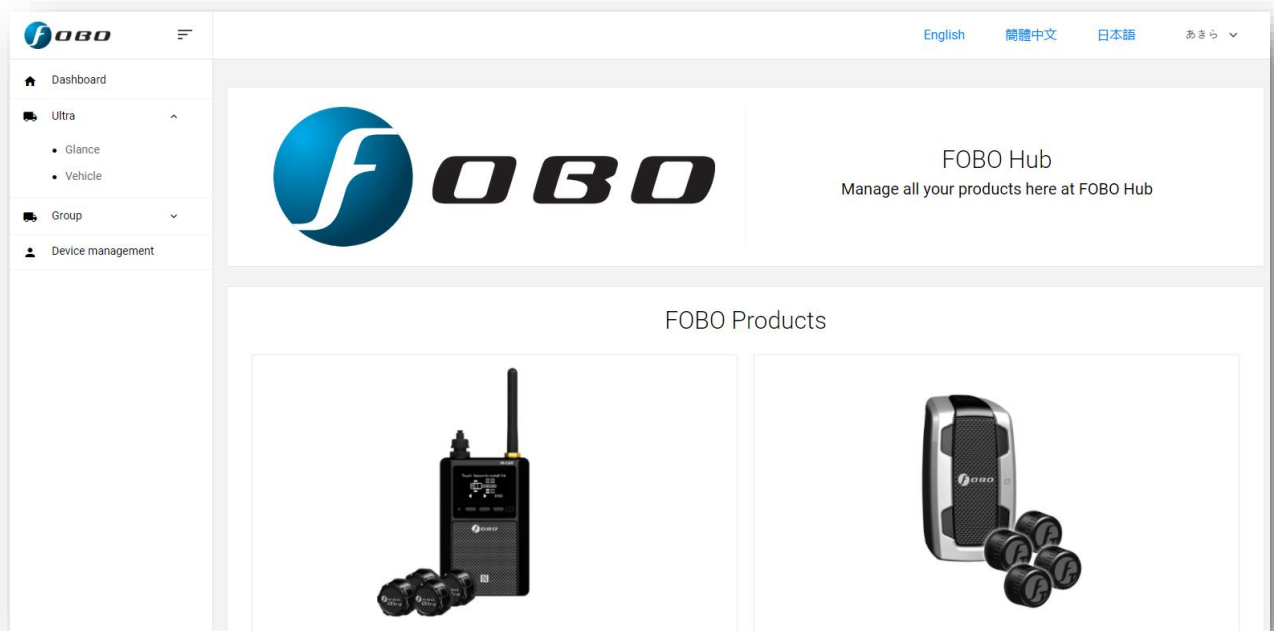

Upon successfully login, user will be redirected to the homepage where user can manage their other products too. The side panel (on left) illustrates the available features at launch.

Feature details:

- **Glance** – It is a summary page to show latest TPMS data for all your installed In-cars or group In-cars/Repeaters.

The screenshot shows the 'Glance' page in the FOBO Ultra interface. The page title is 'Glance' and it is under the 'FOBO Ultra' section. There are tabs for 'kpa', 'psi', 'bar', and 'kgf/cm²'. Below the tabs, there are status indicators: 'Normal' (green) and 'Exceed Maximum/ Exceed Minimum' (red). A table displays the latest pressure data for two airpairs across 14 positions (1:1 to 4:4). The first airpair (AF10990000000Q08) has a pressure of 0 at position 1:1. The second airpair (AF109B0000000Rck) has pressures of 208 at 1:1, 230 at 1:2, 197 at 2:1, and 0 at 2:4. Arrows point to the 'Glance' menu item in the sidebar and the table of data.

Airpair	Name	1:1	1:2	1:3	1:4	2:1	2:2	2:3	2:4	3:1	3:2	3:3	3:4	4:1	4:2	4:3	4:4
AF10990000000Q08	q08	0															
AF109B0000000Rck	vroom	208	230			197			0								

Incars latest pressure data.

Airpair

- Airpair / serial number of the installed In-car / repeater

Name

- Name given to installed In-car / repeater

1:1 to 6:4 (position)

- Latest pressure data scanned according to the installed position. Column will show green if sensor is within defined pre-set threshold settings, otherwise red colour will be shown

- **Vehicle** - A detailed page to show all installed In-car / repeaters as well as those from groups.

The screenshot shows the 'Vehicle' page in the FOBO Ultra interface. The page title is 'FOBO Ultra' and it has a search bar and a 'Show 100 entries' dropdown. A table lists two vehicles with columns for 'Airpair', 'Name', 'BDA', and 'Action'. The first vehicle (AF10990000000Q08) has a BDA of 001588073CD8. The second vehicle (AF109B0000000Rck) has a BDA of 001588074ED7. Arrows point to the 'Vehicle' menu item in the sidebar, the table of vehicles, and the 'View' link for the second vehicle.

Airpair	Name	BDA	Action
AF10990000000Q08	q08	001588073CD8	View
AF109B0000000Rck	vroom	001588074ED7	View

List of vehicles

Click to show full detail of vehicle

Airpair - Airpair / serial number of the installed In-car / Repeater

Name - Name given to installed In-car / repeater

BDA - BDA of the installed In-car / repeater

- **Action** - Click on “View” icon to view detail information of In-car / Repeater

The screenshot displays the OBO web interface with a sidebar on the left containing navigation options like Dashboard, Ultra, Glance, Vehicle, Tracking, Service Recd, Company, Group, and Device manage. The main content area is divided into two sections: 'Bda Document' and 'Last Activity'.

Bda Document Section:

- Units: kpa, psi, bar, kgf/cm², °C, °F (with 'Changeable units' label and arrows pointing to °C and °F).
- Navigation: Previous, Next buttons (with 'Navigate through list of vehicles' label and arrow pointing to Next).
- Fields: Airpair (AF109B000000Rck), BDA (001588074ED7), Owner (Name: vroom, Email: khlee@salutica.com.my).
- Tables:

Axle	Min	MinL2	MinL3	Max	MaxL2	MaxL3	Rec
1	180	170	290	250	270	290	200
2	180	170	290	250	270	290	200

Profile	Temperature	Axle	Min	MinL2	MinL3	Max	MaxL2	MaxL3	Rec
default	50	1	180	170	290	250	270	290	200

Last Activity Section:

- Summary: Last Install: Tue Dec 29 2020 09:42:48 GMT+0800 (Malaysia Time); Last Seen: Wed Jan 20 2021 18:06:38 GMT+0800 (Malaysia Time); Last Sync: khlee@salutica.com.my; Last Latitude: 4.54835176; Last Longitude: 101.07256396; Last Speed: 0.00; Last Accuracy: 10.32.
- Sensor Table:

Sensor Bda	Axle (F to R)	Position (L to R)	Pressure	Temperature	Battery	Battery_J	Last Seen
0015880750A0	1	1	208	34	3016	2864	Wed Jan 20 2021 18:07:22 GMT+0800 (Singapore Standard Time)
0015880750B2	2	1	197	31	3000	2822	Wed Jan 20 2021 18:07:30 GMT+0800 (Singapore Standard Time)
00158807448A	2	4	0	29	3071	2875	Wed Jan 20 2021 18:06:37 GMT+0800 (Singapore Standard Time)
00158807447B	1	2	230	33	3014	2841	Wed Jan 20 2021 18:07:20 GMT+0800 (Singapore Standard Time)

Annotations in the image include 'Clickable' with an arrow pointing to the highlighted sensor row (00158807448A).

(Picture above illustrates detail view of vehicle information)

Airpair	- Airpair / Serial number of the In-car / repeater
BDA	- BDA of the In-car / repeater
Name and Owner	- Show the vehicle name and owner email
Axles Settings	- Current Axle settings
Pre-set Settings	- Show all available settings
Information	- In-car firmware, temperature threshold as well as number of axles
BDAs and Sensor information	- Show hooked repeaters (For In-car only) - All sensors installed (BDA of sensors)
Current Profile	- Show current profile being set to the In-car / repeater
Last Activity	- Show all last activities, includes <ul style="list-style-type: none">- Last install (Date of install)- Last seen (Date of last sync)- Last sync (Last sync by who)- Last latitude (Last latitude)- Last longitude (Last longitude)- Last speed (Last km/h)- Last accuracy (Last accuracy per meter)
Sensor	- Show all installed sensor latest data <ul style="list-style-type: none">- Sensor BDA- Axle (which axle)- Position (which position on the axle)- Pressure- Temperature- Battery- Battery L- Last seen (Last sync with sensor) <p>Row will show red colour if there is any error to the sensor</p>

Clicking on the sensor BDA will render two different graphs as illustrated below.

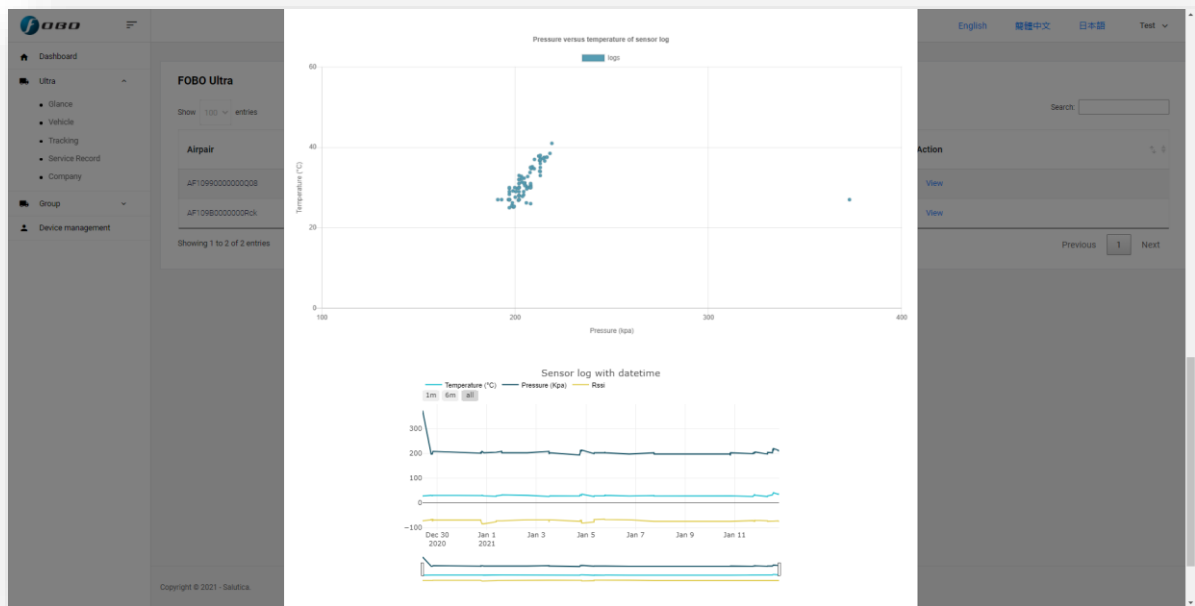

Graph 1 Illustrates Pressure versus Temperature graph

Graph 2 Illustrates chart with pressure, RSSI and temperature at the same time.

- **Groups**

The screenshot shows the 'GROUP' management view in the fobo dashboard. It features a 'Create Group' section with a 'CREATE NEW GROUP' button and a search field. Below this is a table listing existing groups. The table has columns for 'Group Name', 'Number Of Members', 'Founded', and 'Action'. Two groups are listed: 'my family' (2 members, founded 16 December 2020) and 'Salutica' (5 members, founded 11 November 2020). Annotations with arrows point to the 'Group' menu item, the 'CREATE NEW GROUP' button, the table, and the 'Edit' link for the 'Salutica' group.

Group Name	Number Of Members	Founded	Action
my family	2	16 December 2020	Edit
Salutica	5	11 November 2020	Edit

(Picture above illustrates group view)

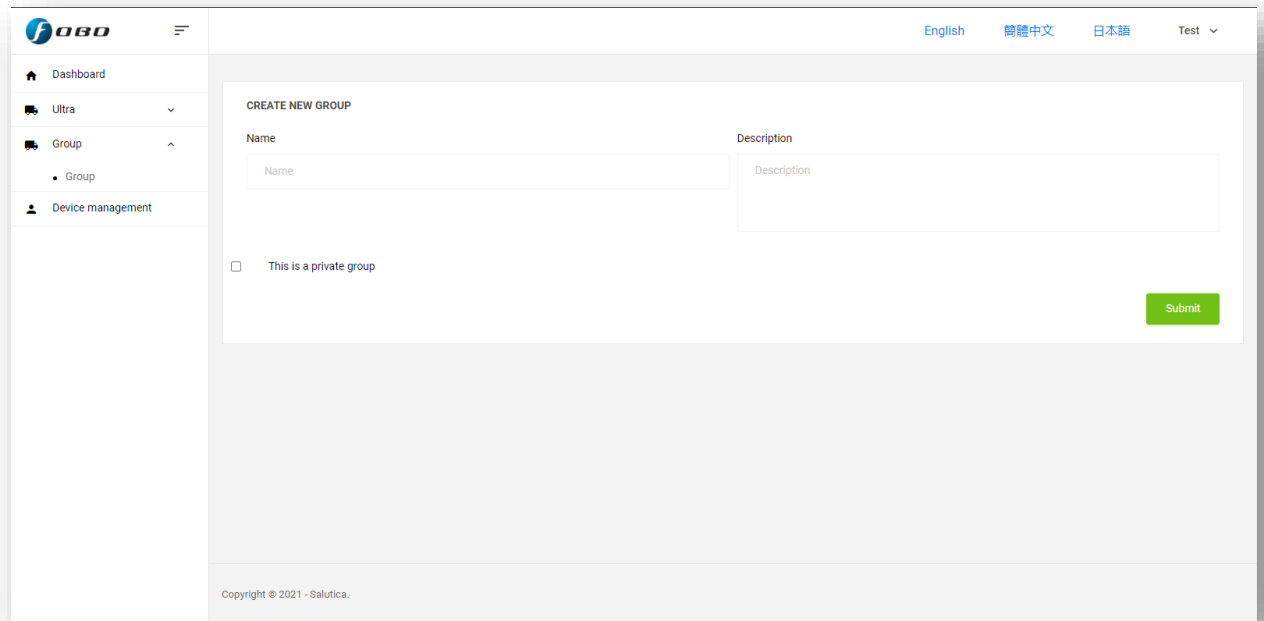

(Picture above illustrates create group view)

Name - Name of group

Description - Description of group

Private group - To define whether group is searchable by others (Feature to be available)

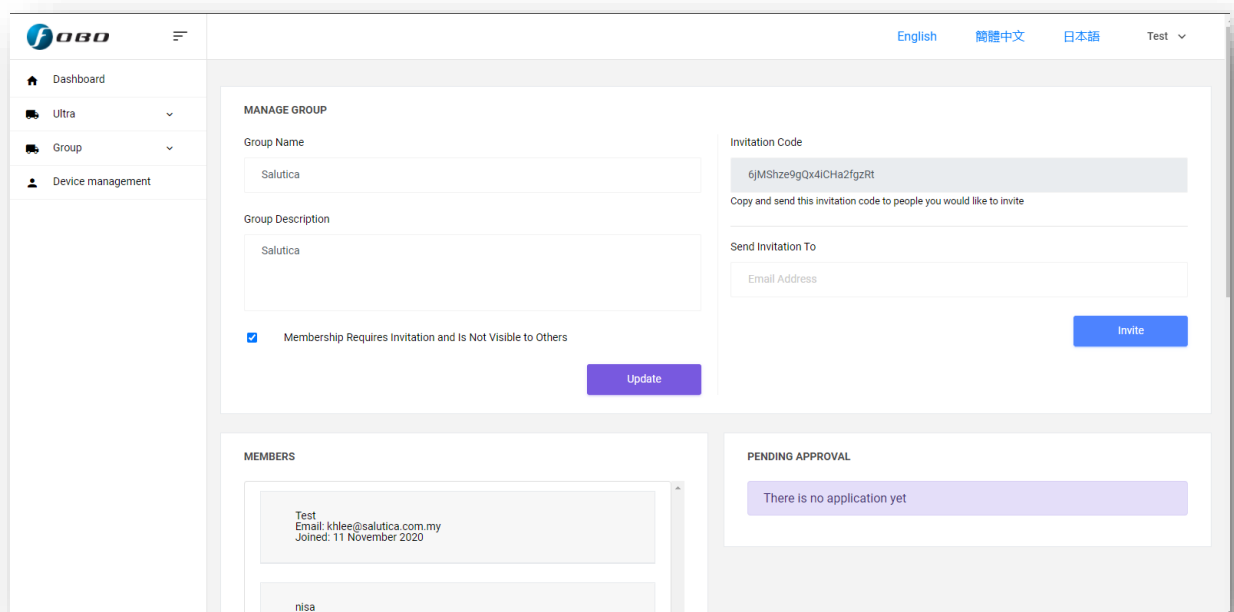

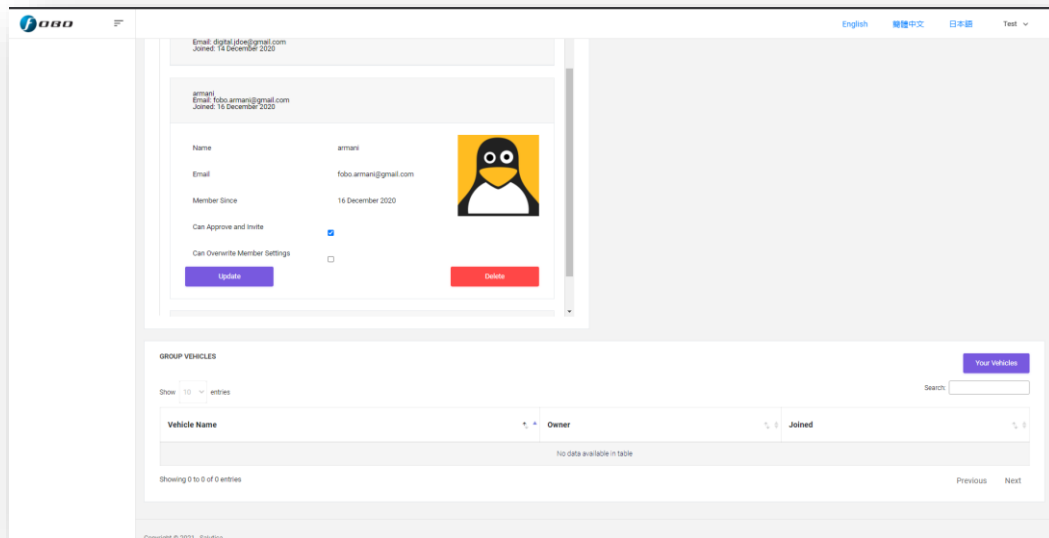

(Both pictures above illustrate the group edit view.)

- Group Name** - Name of the group
- Group Description** - Description of the group
- Private group toggle** - To define whether group is searchable by others (Feature to be available)
- Invitation Code** - Unique code of the group to send to another member to join the group (Feature to be available)
- Send Invitation To Members** - Send group invitation to input email
- Manage existing group members
- Pending Approval** - Manage join group requests
- Group Vehicles** - List of vehicles being assigned to the group (Refer to the below image)

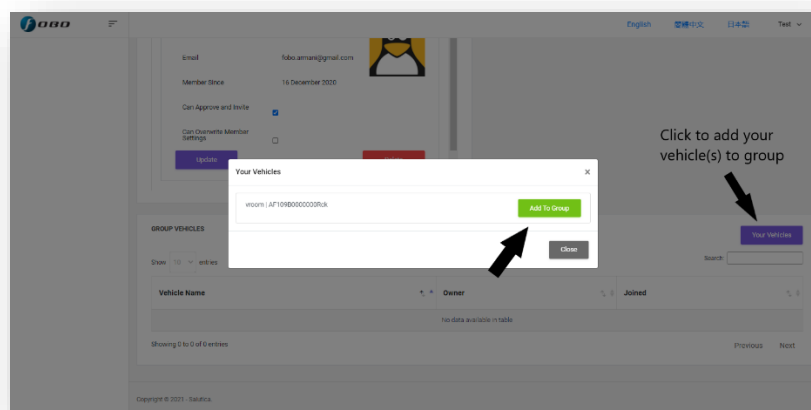

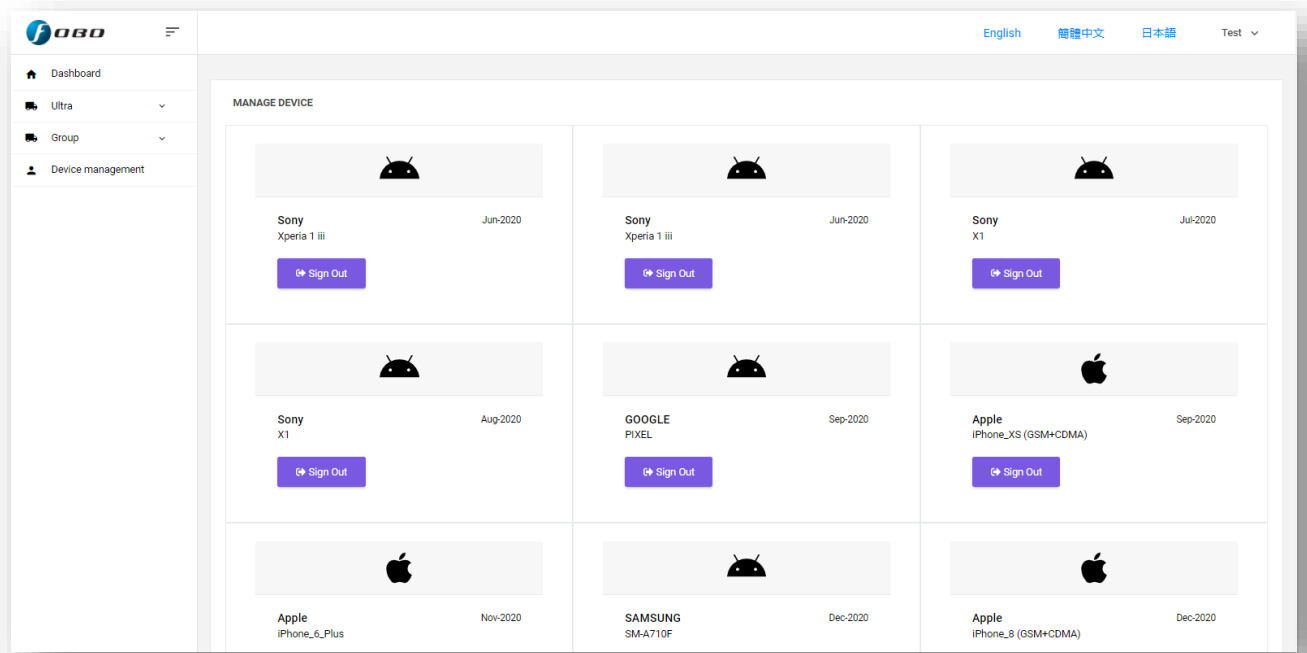

(Picture above illustrates the device management page where user can manage their logged in devices. Clicking on the sign out button will log out user from selected account.)

5.10 FOBO Company

User can apply for company account to manage all the company's vehicles, manage staffs, and manage division and regions.

In Company, company Owner/Authorized person can create branch and assign vehicles to designated branch. FOBO Company utilized hierarchy architecture to design company. Those who are at higher level of the branch can access and view all information of the lower levels, and any branch will not have access to other branch data.

Furthermore, company Owner/Authorized person can grant authority to the member of their choice to manage the company, which are; invite members and add branches, assigning vehicles, and update in-car settings. These authorized personnel then can assign other members with permissions that are given to the authorized personnel only. For example, if A is given permission to invite members ONLY, he will only be able to give the member of his choice the same permission ONLY.

Those who were given permission to invite members can also relocate members from one branch to another branch. The relocation of branch is limited to the branch level of the assigner. Relocation cannot be done if the assigner tries to assign any member to any branch higher than the branch of the assigner. If such relocation to be perform, assigner will have to request the authorized personnel from the higher branch level.

How to Apply for a company?

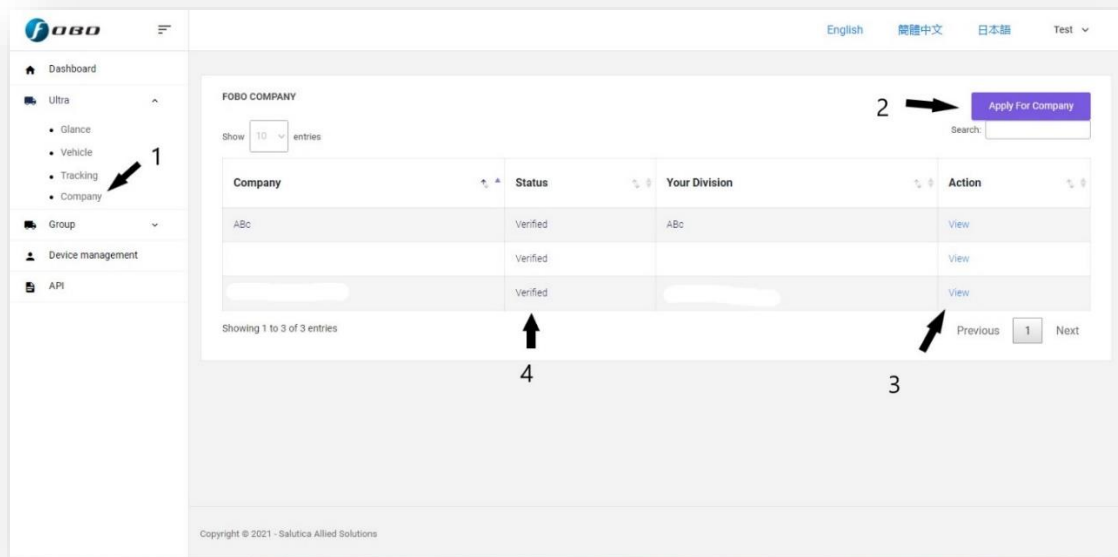

Image above illustrates the FOBO Company Feature homepage.

1. Navigates to Company Feature homepage.
2. Apply a company, will requires FOBO Admin to approve.
3. View profile of the company
4. Indicates the status of company application.

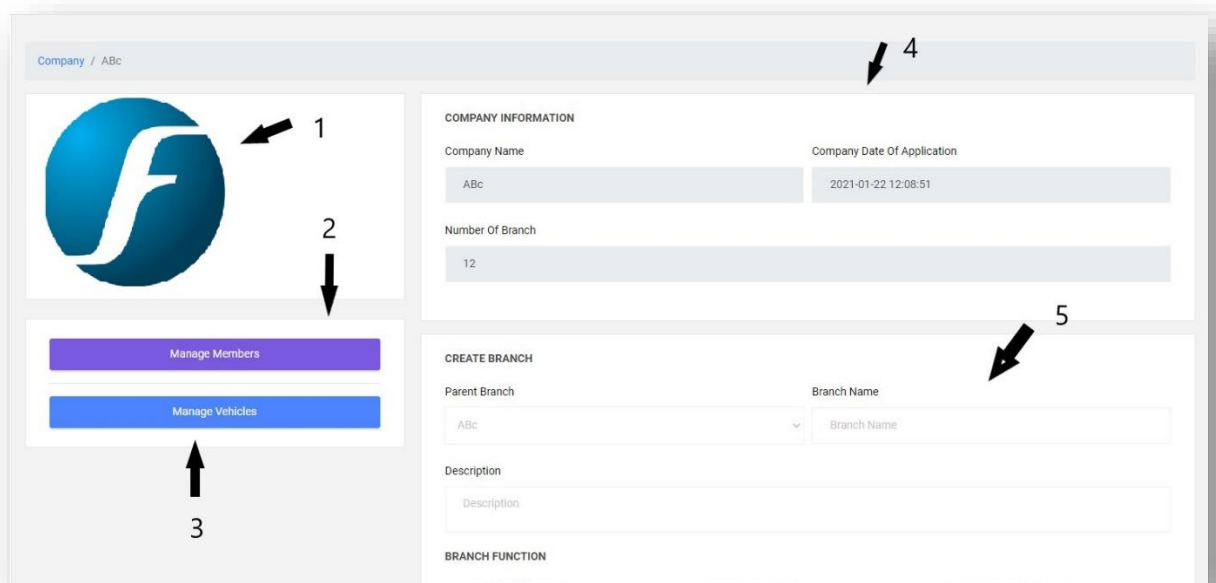
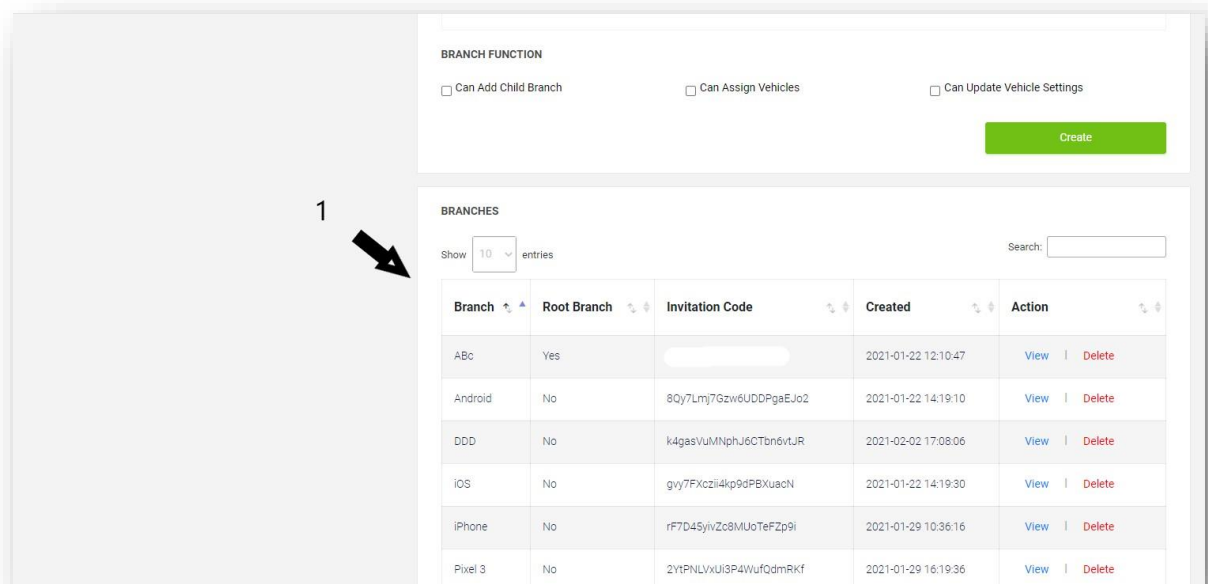

Image above illustrates Company Profile page.

- 1- Company LOGO
- 2- Clicking on Manage Members will redirect to manage members page.
- 3- Clicking on Manage Vehicles will redirect to manage vehicles page
- 4- This area shows the company information.
- 5- This area allows to create branch (if given permission) based on their setting.
 - a. Can add child branch (Include permission to invite members)
 - b. Can assign vehicles (Vehicles being assign to company can be reassign to other branches under the user's branch)
 - c. Can update vehicle settings (Allow user to modify in-car settings)



The image above illustrates the branches of the select branch.

- 1- Shows the branches under the selected branch view. Where user can either view or delete the branch (If given permission, but user is unable to delete the branch he is in)

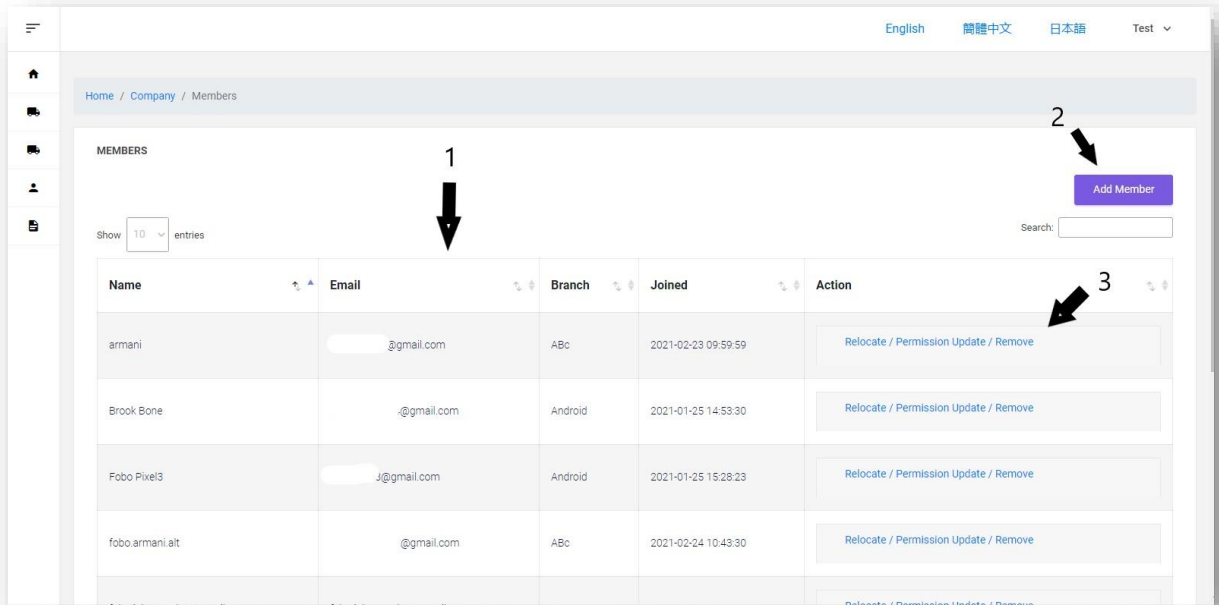

The image above illustrates the Manage Members page.

- 1- Shows all members' details.
- 2- Allow user to add member(s) (if given permission)
- 3- Expand this selection to allow user to relocate member, update their permission and remove them from company (If given permission)

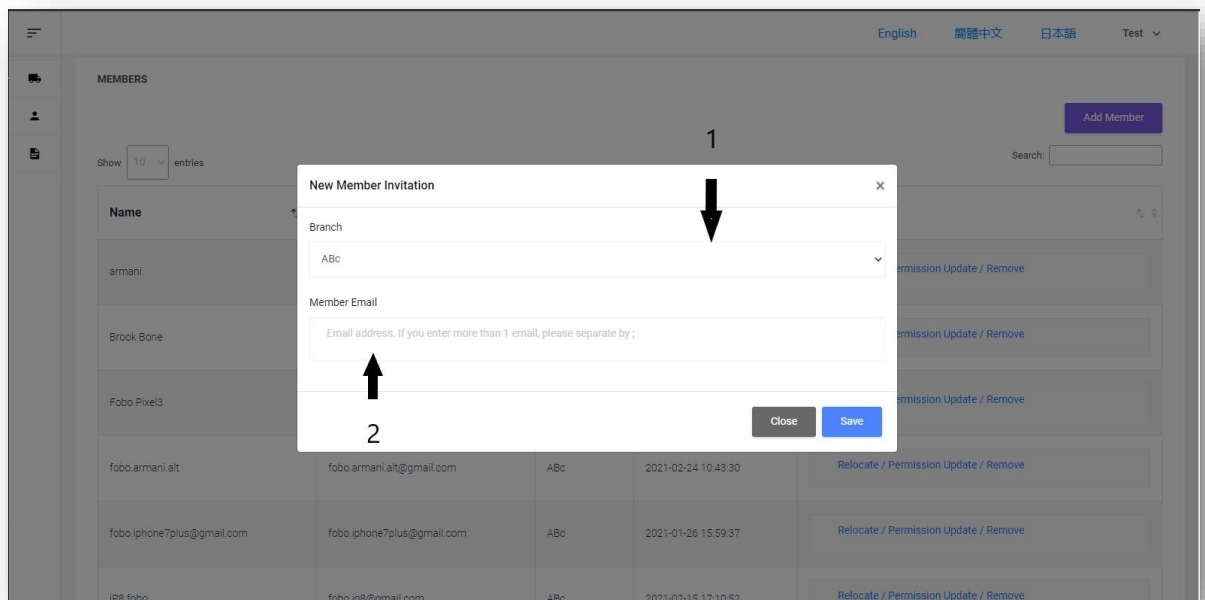

Image above illustrate the Add Member page at the Manage Members page.

1. Allow user to select branch

2. Allow user to key in email(s) that they wish to invite to the company. (An email will be sent to invitees)

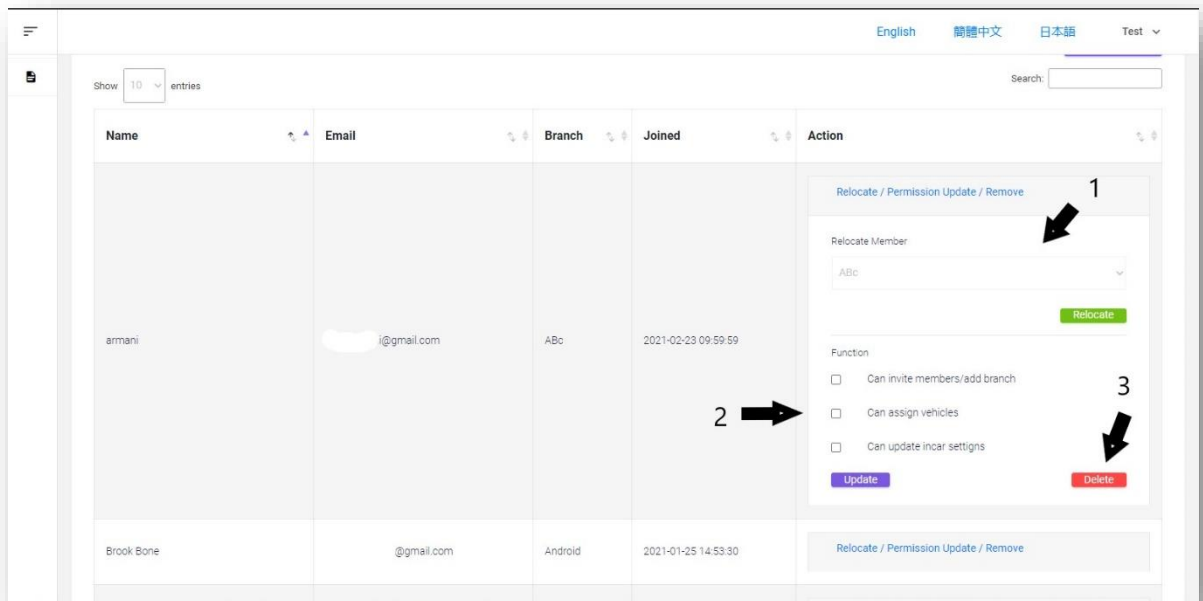

Image above illustrates the expansion for member at Manage Members page.

- 1- Relocating selected member to another branch.
- 2- Grant selected member permission to perform tasks.
- 3- Remove member from the company.

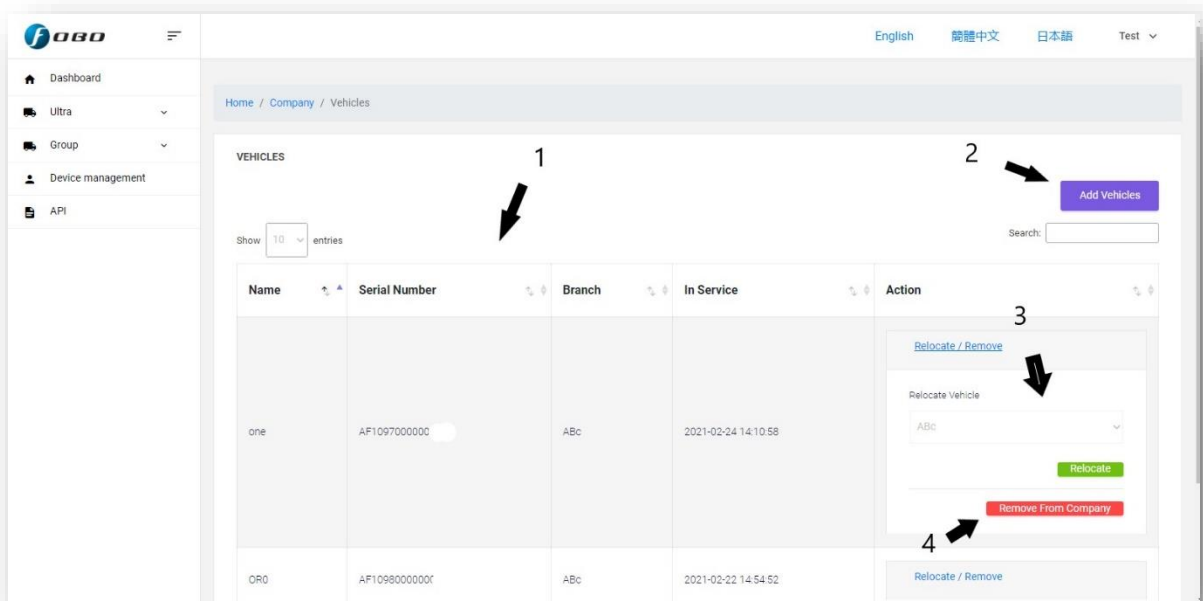

Image above illustrates the Manage Vehicles page.

- 1- Show details of vehicles being assigned to the company.
- 2- Allow root branch to assign their vehicle(s) to the company
- 3- Relocate selected vehicle to another branch.
- 4- Remove assignment of vehicle from company.

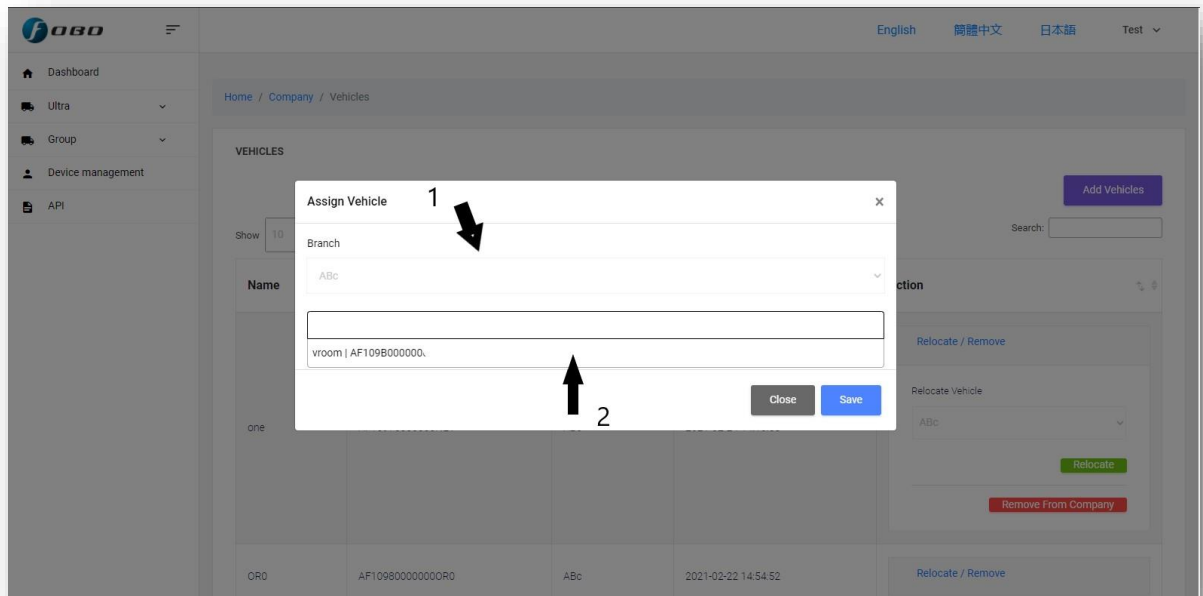

Image illustrates the Add Vehicles interface at Manage Vehicles page.

- 1- Allow user to select branch for their vehicle(s) to be assign to
- 2- Select available vehicle from user's account. (A vehicle can only be assigned to one company)

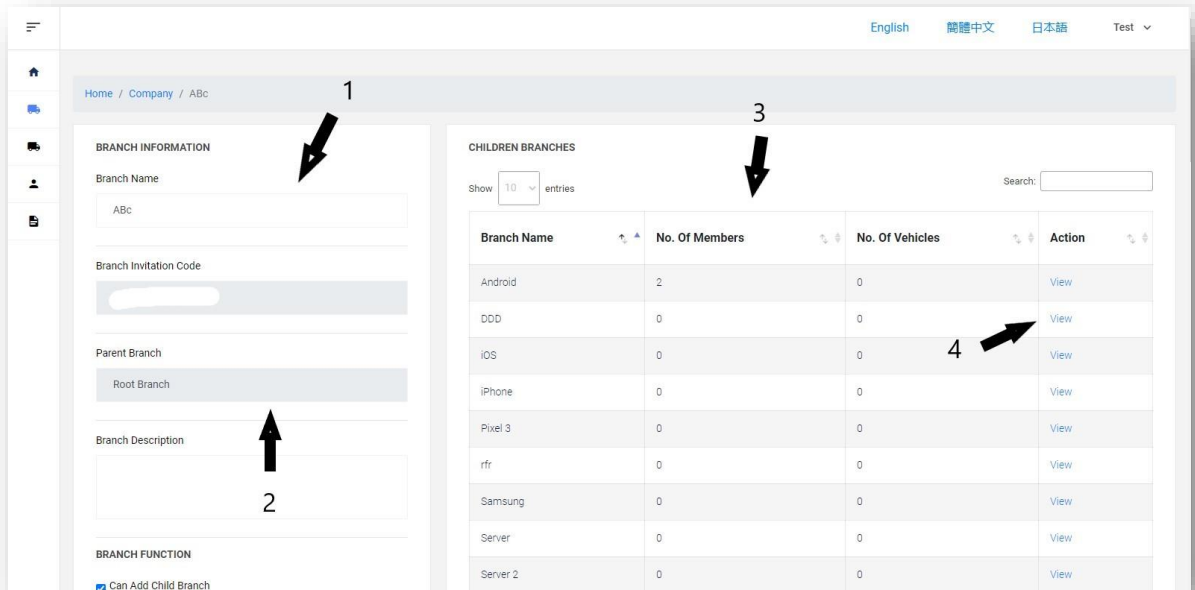

Image above illustrates branch view. (pt1)

1. Branch information is shown here.
2. Parent branch of the branch is being shown here. Root Branch indicates that it is root of the company.
3. Show children branches of the selected branch.
4. View branch view of selected branch.

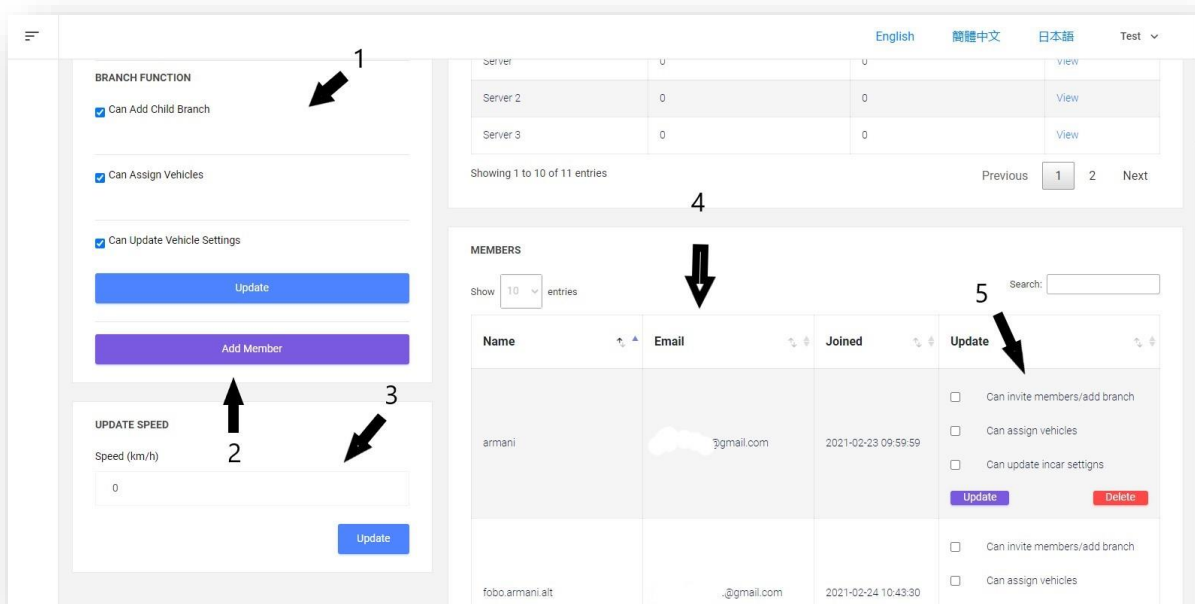

Image above illustrates branch view. (pt2)

- 1- Given branch permission to the branch. (Branch permission will limit what the member of the branch can do. For example, if can add child branch permission is not given to the branch, no member of the branch can have that permission)
- 2- Allow user (with given permission) to invite member to the branch
- 3- Allow alert to user (Function to be implemented, might requires subscription) if members under the branch (include children branches) speeding exceed defined speed.
- 4- Table shows all the members of the branch.
- 5- Allow user to update permission of the selected member (If given permission)

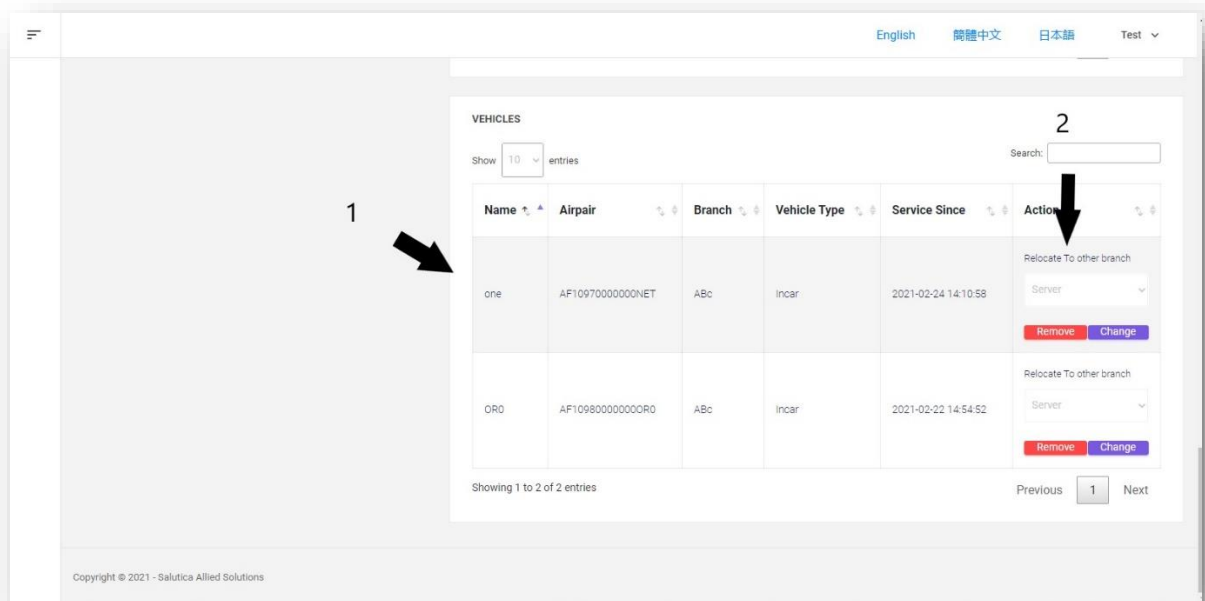

Image above illustrates branch view. (pt3)

1. Table shows vehicles being assigned to the branch and the children branches of the selected branch.
2. Allow user to relocate or remove the vehicle from the company. (If given permission)

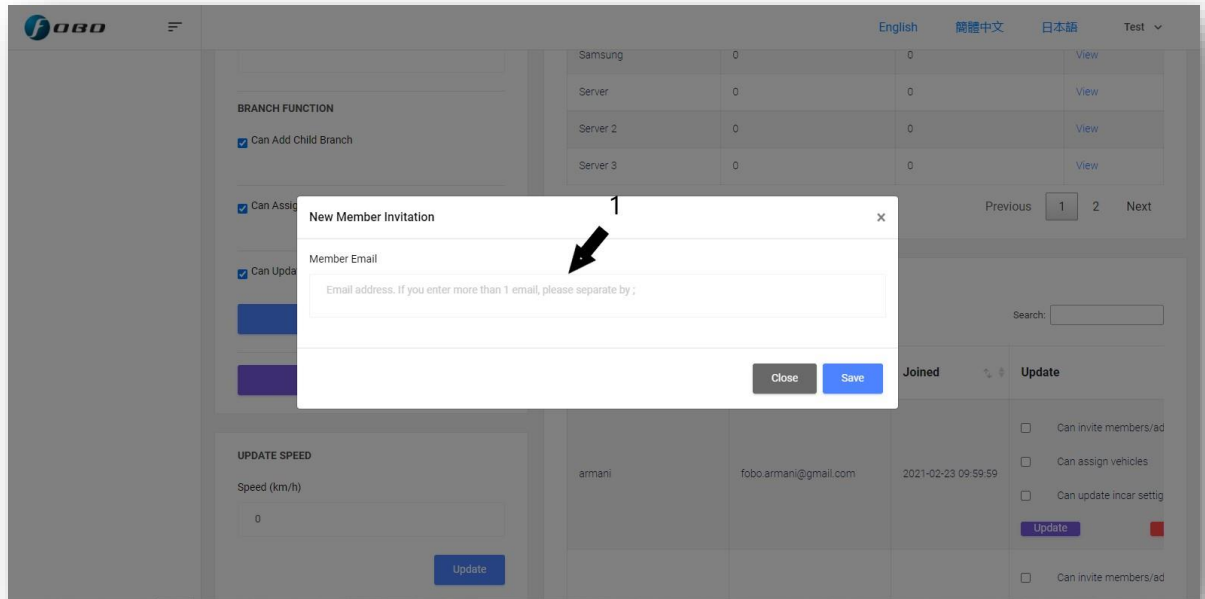

Image above illustrates branch view. (pt4)

- 1- Allow user to invite member(s) to the branch (If given permission)

6 In-Car unit/Repeater Audio & LED Alerts

The In-Car/Repeater unit will produce different tones and LED flashes for different situations. For repetitive alerts, you can stop the alerts by long press the In-Car unit/Repeater button once, however LED will continue to flash until user solve the issue.

Wake up – unit will produce “two tones (High- low)”, this shows that In-Car unit is awake and operational.

Sleep – unit will produce “one long tone (Low)” once, No LED will blink. This shows In-Car/Repeater unit is going to sleep and not operational.

In-Car/Repeater unit goes to sleep to conserve battery when vehicle is not moving for 15 minutes. However, the sensors will still be operational 24x7 and continue to monitor and alert to your smartphone in case of flat tire.

WARNING: FOBO ULTRA IS A MONITORING DEVICE TO ALERTS THE USER WHEN IT DETECTS SIGNALS THAT IS OUT OF PRE-SET CONDITIONS BASED ON THE SETTING BY THE USER. THE USER OR DRIVER IS SOLELY RESPONSIBLE TO FIND OUT THE ACTUAL CONDITION OF THE TIRE AND TO ENSURE PROPER TIRE MAINTENANCE. FOBO Ultra IS NOT RESPONSIBLE FOR WRONG DIAGNOSTICS OR FALSE ALERTS THAT MAY CAUSE INCONVENIENCE.

Summary of Alerts:

Sr No.	Alert type	Red LED	Amber LED	Audible tone	Display
1	InCar Unit Startup	One time on	One time on	2 tones (low-high) will occur once.	-
2	L1 (8% below or 25% above recommended tire pressure)	-	Constant on	5 tones (high) will occur once. Alert will re-occur when InCar unit wakes up, provided tire condition remains the same.	-
3	L2 (15% below or 35% above recommended tire pressure)	-	Constant on	3 times (high-low) tone will occur continuously every 5s. It can be cancelled by long press on LEFT button. It will stop if InCar unit enters sleep mode or measures data back to normal. Alert will re-occur when the InCar unit wakes up, provided tire condition remains the same.	-
4	L3 (25% below or 45% above recommended tire pressure)	-	Constant on	3 times (high-low) tone will occur continuously every 5s. It can be cancelled by long press on LEFT button. It will stop if InCar unit enters sleep mode or measures data back to normal. Alert will re-occur when the InCar unit wakes up, provided tire condition remains the same.	-
5	Low Battery (InCar)	1 blink every 5s	-	-	Pop up low battery message whenever the screen is turned on. User need to press "OK" to hide the message.
6	Low Battery (Sensor)	1 blink every 5s	-	-	In tire status page, battery level column, show "--V".
7	Missing Sensor	-	5 fast blink.	-	-
8	Missing Repeater	1 blink every 5s	-	-	Trailer body shows blinking in the Hooked Device Page.
9	Temperature	-	Constant on	2 beeps every 5s	-

7 Replacing Battery – Sensor, In-Car & Repeater

Sensor Battery Replacement:

The coin cell battery (CR2032) used in the FOBO Ultra sensors could last up to Twelve months based on normal operating condition. Operating in extreme cold or hot temperatures may reduce battery operating life for both the tire sensors and the In-Car unit.

You will receive an alert on the smartphone and In-Car unit/Repeater when the sensor or In-Car unit/Repeater battery levels are low. You will be alerted every time you start to drive your vehicle until the battery is replaced. It is advisable to change the battery once you receive this battery alert to ensure proper performance of FOBO Ultra. Do not wait until the battery is fully drained as it will cause FOBO Ultra to stop working properly.

To replace the battery of sensor unit, unscrew the top cover. Be careful not to damage the rubber gasket as it may affect water resistance of the sensor unit. Ensure the battery (CR2032) is inserted with the “+” sign facing up, away from the PCB.

Correct Way to Insert Battery

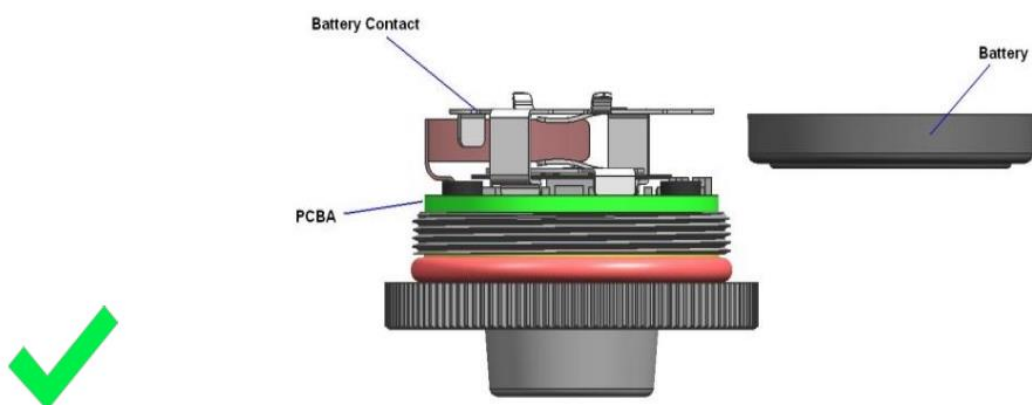

Incorrect Way to Insert Battery

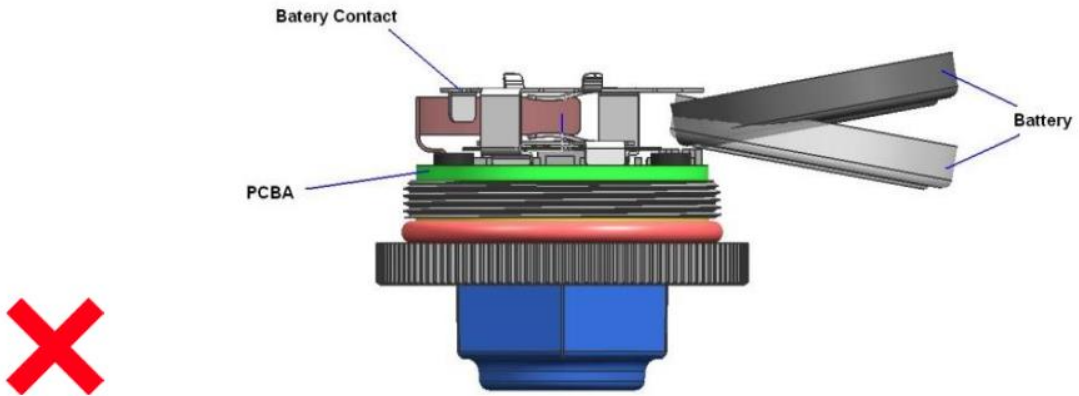

In-Car Unit Battery Replacement:

To replace battery for the In-Car unit, open the battery cover and take out the battery pack. Ensure the battery (AA) is inserted in the correct orientation. It is advisable to use good quality AA batteries (recommended Lithium or Alkaline) for long lasting performance of In-Car unit.

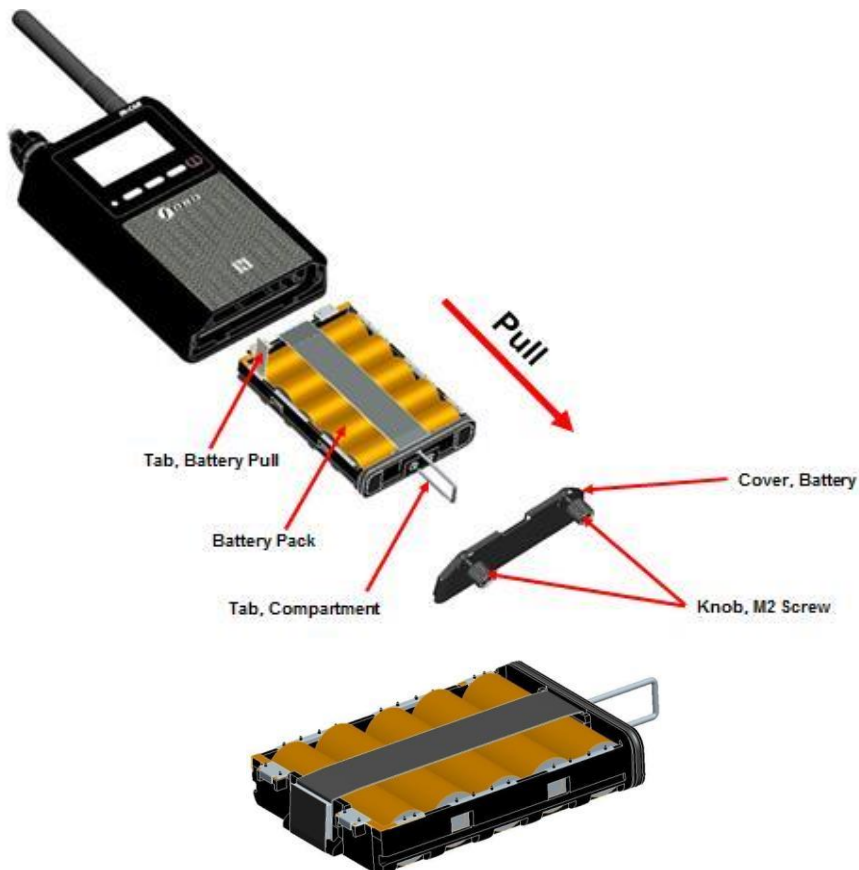

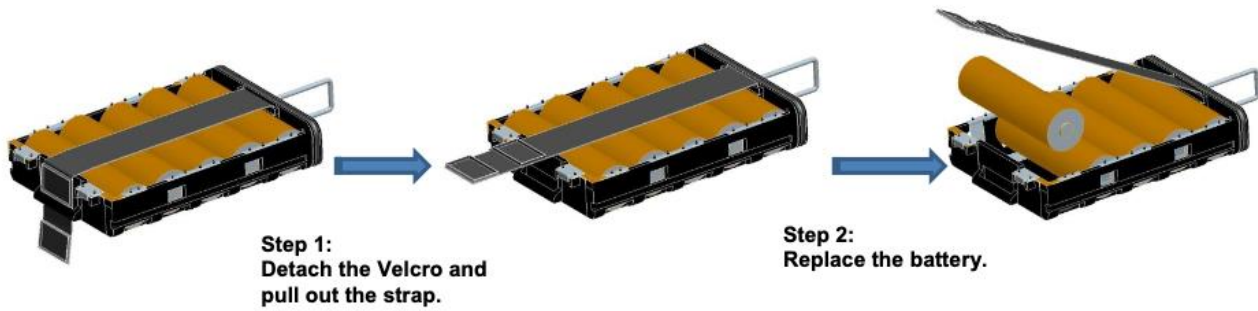

Repeater Unit Battery Replacement:

To replace battery for the Repeater unit, open the battery cover and take out the battery pack. Ensure the battery (AA) is inserted in the correct orientation. It is advisable to use good quality AA batteries (recommended Lithium or Alkaline) for long lasting performance of In-Car unit. User does not need to remove the whole repeater unit while replacing the battery. Refer to the illustration below showing repeater unit battery replacement.

Instructions:

Step 1: Unscrew both Knob, M2 Screws just until Cover, Battery can be remove

Step 2: Pull out the Tab, Compartment.

Step 3: Replace the batteries (as shown below)

Step 4: Insert back battery pack followed by Cover Battery

Step 5: Tighten both two Knob, M2 Screws

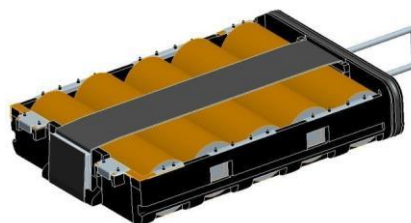
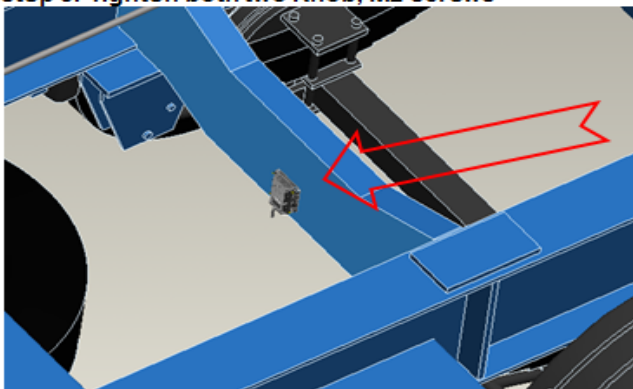

Battery Pack Condition

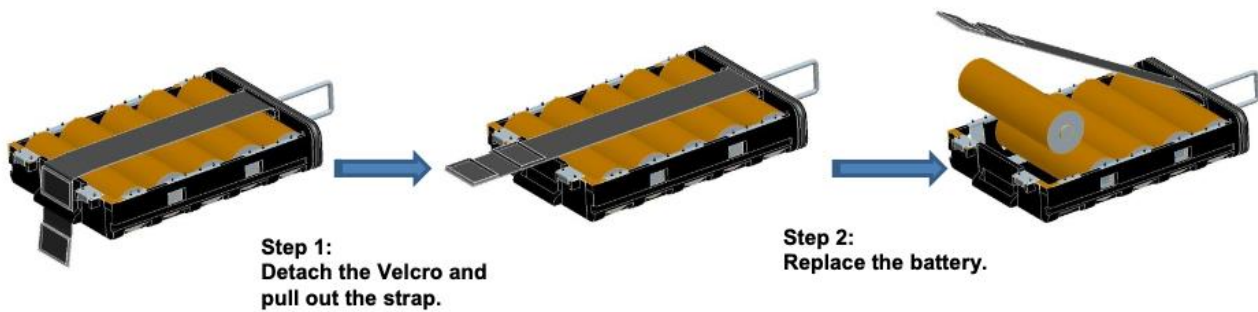

8 Troubleshooting Guide

1. Could not sign up a new FOBO account (did not receive activation e-mail):

- Check the e-mail address entry is typed correctly,
- Check the Spam mailbox, in case the e-mail was filtered by the e-mail server,
- Check the smartphone is connected to internet and able to receive e-mail.

2. Could not sign up a new FOBO account (received activation e-mail):

- Make sure to click on the “Activation” link of the latest e-mail, in case there are multiple authentication e-mails,
- You should be directed to web page that clearly displayed “FOBO account is activated”.

3. Unable to Login after signing up to FOBO App:

- Make sure your e-mail address is typed correctly,
- A verification mail will be sent to your e-mail address,
- Follow the instruction in the mail to activate your account before you can Login,
- Check if internet connection is available on your smartphone.

4. Unable to pair FOBO Ultra In-Car unit/Repeater:

- Make sure the battery is installed correctly and battery tab is removed.
- Make sure your smartphone has Bluetooth 4.0 or later (Smart Ready) capability. **NOTE: BLUETOOTH 2.0 OR 3.0 WILL NOT WORK WITH THIS DEVICE.**
- Please check if the FOBO Ultra has been paired before to another FOBO account. You’ll need to “Release” the FOBO Ultra set from the FOBO account that it is paired to, before using on your account. The FOBO Ultra is designed to pair with one FOBO account only for theft deterrent feature.
- Try to reset the Bluetooth manager of your smartphone (for iOS: Settings-> Bluetooth-> OFF->ON). At times the Bluetooth manager may be disrupted which may require manual reset.

- Try to do a hard reset on the phone.

9 FOBO Ultra Specifications

Sensor Specifications (Model - TU1602):

- Maximum Pressure 1296 Kpa (188 psi)
- Pressure Accuracy:
1 σ = +/- 0.79 psi (0 to + 50 °C) 1 σ = +/- 1.06 psi (-40 to + 85°C)
- Temperature Accuracy:
1 σ = +/- 1 °C (0 to + 50 °C)
1 σ = +1.33 / - 1°C (-40 to + 85°C)
- Operational temperature range: -40 to 85°C
- Up to 12 months battery life CR2032
- Dust protected & Waterproof: IP57
- Light weight sensors. Only 12.6 g each
- Certification: FCC, CE, BQB and RoHS
- Mechanical & Environmental Reliability Testing Standards: IEC 60068-2-2, IEC 60068-2-1, IEC 60068-2-29, IEC 60068-2-5, IEC 60068-2-32, ISO 15184, ISO 2409, SAE J2848 , SAE J1455
- Bluetooth 4.1 (Compatible with Bluetooth 4.0 or later)
- Compatible with iOS 12.0 or Android 6.0 or later.
- Input Rating: 3.0 Vdc, 30uA

In-Car / Repeater Specifications (Model - TU1601):

- Operational temperature range: -40 to 85°C
- Battery life: up to 2 months
- Power source: Battery AA x 5 pcs or 12V to 24V external supply
- Operating Temperature
 - With vehicle power source: -40°C ~ +85°C
 - With Alkaline batteries: -18°C ~ +50°C
- Storage Temperature:
 - Without Alkaline battery: -40°C ~ +85°C
 - With Alkaline battery: -30°C ~ +45°C
- Weight: 100g (without battery) 220g with 5x alkaline batteries
- Dust protected & Waterproof: IP57 (Repeater only)
- Certification: FCC, CE, BQB and RoHS
- Mechanical & Environmental Reliability Testing Standards: IEC 60068-2-2, IEC 60068-2-1, IEC 60068-2-29, IEC 60068-2-5, IEC 60068-2-32, ISO 15184, ISO 2409, SAE J2848, SAE J1455
- Bluetooth 4.1 (Compatible with Bluetooth 4.0 or later)
- Compatible with iOS 12.0 or Android 6.0 or later
- NFC
- Input Rating: 7.5Vdc or 12-24Vdc, 65mA

10 Warning

- Take note that FOBO Ultra is not meant to function as anti-accident or anti-injury device. FOBO Ultra is not a substitute for safe tire maintenance practices. Please take full responsibility of your own safety while driving. And continue to send your car for regular tire check and maintenance.
- Please take extra precaution to acoustics safety when operating the FOBO Ultra In-Car unit. Note that placing the FOBO Ultra In-Car unit beeper close to your ear may result in injury to the ear or permanent loss of hearing.
- You shall not use the FOBO Ultra in any unlawful way that violates any laws.
- Avoid exposing the FOBO Ultra In-Car unit and sensors to solvent, fire or extreme temperatures.
- FOBO Ultra may fail to function properly if the battery is below optimum level. Replace the battery immediately to continue enjoying full features of FOBO Ultra.

CAUTION

THERE MAY BE A RISK OF EXPLOSION IF BATTERY IS REPLACED BY AN INCORRECT TYPE. DISPOSE ALL USED BATTERIES PROPERLY.

11 Regulatory Information

Federal Communication Commission Interference Statement

This device (PTP-TU1601) complies with Part 15 of the FCC Rules. Operation is subject to the following two conditions: (1) This device may not cause harmful interference, and (2) this device must accept any interference received, including interference that may cause undesired operation.

This equipment has been tested and found to comply with the limits for a Class B digital device, pursuant to Part 15 of the FCC Rules. These limits are designed to provide reasonable protection against harmful interference in a residential installation. This equipment generates, uses and can radiate radio frequency energy and, if not installed and used in accordance with the instructions, may cause harmful interference to radio communications. However, there is no guarantee that interference will not occur in a particular installation. If this equipment does cause harmful interference to radio or television reception, which can be determined by turning the equipment off and on, the user is encouraged to try to correct the interference by one of the following measures:

- Reorient or relocate the receiving antenna.
- Increase the separation between the equipment and receiver.
- Connect the equipment into an outlet on a circuit different from that to which the receiver is connected.
- Consult the dealer or an experienced radio/TV technician for help.

FCC Caution: Any changes or modifications not expressly approved by the party responsible for compliance could void the user's authority to operate this equipment.

This transmitter must not be co-located or operating in conjunction with any other antenna or transmitter.

Radiation Exposure Statement:

The product (PTP-TU1601) comply with the FCC portable RF exposure limit set forth for an uncontrolled environment and are safe for intended operation as described in this manual. The further RF exposure reduction can be achieved if the product can be kept as far as possible from the user body or set the device to lower output power if such function is available.

Industry Canada Statement:

This device (10617A-TU1601) complies with ISED's licence-exempt RSSs. Operation is subject to the following two conditions: (1) This device may not cause harmful interference, and (2) this device must accept any interference received, including interference that may cause undesired operation.

Le présent appareil est conforme aux CNR d'ISED applicables aux appareils radio exempts de licence. L'exploitation est autorisée aux deux conditions suivantes : (1) le dispositif ne doit pas produire de brouillage préjudiciable, et (2) ce dispositif doit accepter tout brouillage reçu, y compris un brouillage susceptible de provoquer un fonctionnement indésirable.

Radiation Exposure Statement:

The product (10617A-TU1601) comply with the Canada portable RF exposure limit set forth for an uncontrolled environment and are safe for intended operation as described in this manual. The further RF exposure reduction can be achieved if the product can be kept as far as possible from the user body or set the device to lower output power if such function is available.

Déclaration d'exposition aux radiations:

Le produit est conforme aux limites d'exposition pour les appareils portables RF pour les Etats-Unis et le Canada établies pour un environnement non contrôlé.

Le produit est sûr pour un fonctionnement tel que décrit dans ce manuel. La réduction aux expositions RF peut être augmentée si l'appareil peut être conservé aussi loin que possible du corps de l'utilisateur ou que le dispositif est réglé sur la puissance de sortie la plus faible si une telle fonction est disponible.

Federal Communication Commission Interference Statement

This device (PTP-TU1602) complies with Part 15 of the FCC Rules. Operation is subject to the following two conditions: (1) This device may not cause harmful interference, and (2) this device must accept any interference received, including interference that may cause undesired operation.

This equipment has been tested and found to comply with the limits for a Class B digital device, pursuant to Part 15 of the FCC Rules. These limits are designed to provide reasonable protection against harmful interference in a residential installation. This equipment generates, uses and can radiate radio frequency energy and, if not installed and used in accordance with the instructions, may cause harmful interference to radio communications. However, there is

no guarantee that interference will not occur in a particular installation. If this equipment does cause harmful interference to radio or television reception, which can be determined by turning the equipment off and on, the user is encouraged to try to correct the interference by one of the following measures:

- Reorient or relocate the receiving antenna.
- Increase the separation between the equipment and receiver. Connect the equipment into an outlet on a circuit different from that to which the receiver is connected.
- Consult the dealer or an experienced radio/TV technician for help.

FCC Caution: Any changes or modifications not expressly approved by the party responsible for compliance could void the user's authority to operate this equipment.

This transmitter must not be co-located or operating in conjunction with any other antenna or transmitter.

Radiation Exposure Statement:

This equipment (PTP-TU1602) complies with FCC radiation exposure limits set forth for an uncontrolled environment. This equipment should be installed and operated with minimum distance 20cm between the radiator & your body.

Industry Canada statement:

This device (10617A-TU1602) complies with ISED's licence-exempt RSSs. Operation is subject to the following two conditions: (1) This device may not cause harmful interference, and (2) this device must accept any interference received, including interference that may cause undesired operation.

Le présent appareil est conforme aux CNR d'ISED applicables aux appareils radio exempts de licence. L'exploitation est autorisée aux deux conditions suivantes : (1) le dispositif ne doit pas produire de brouillage préjudiciable, et (2) ce dispositif doit accepter tout brouillage reçu, y compris un brouillage susceptible de provoquer un fonctionnement indésirable.

Radiation Exposure Statement:

This equipment (10617A-TU1602) complies with ISED radiation exposure limits set forth for an uncontrolled environment. This equipment should be installed and operated with minimum distance 20cm between the radiator & your body.

Déclaration d'exposition aux radiations:

Cet équipement est conforme aux limites d'exposition aux rayonnements ISED établies pour un environnement non contrôlé. Cet équipement doit être installé et utilisé avec un minimum de 20 cm de distance entre la source de rayonnement et votre corps.

European Union Regulatory Conformance

This equipment is CE marked according to the provisions of the R&TTE Directive (99/5/EC) and is in compliance with the essential requirements and other relevant provisions of the Directive 1999/5/EC. This equipment meets the following conformance standards:

EN 300 328, EN62479, EN 301 489-1&17, EN 60950-1

EU Declaration of Conformity

Hereby, Salutica Allied Solutions Sdn. Bhd. declares that this Bluetooth device is in compliance with the essential requirements and other relevant provision of Directive 1999/5/EC.

Caution: Changes or modifications to this FOBO device not expressly Approved by the party responsible for compliance could void the user's authority to operate it.

Bluetooth Wireless Compatibility:

This FOBO device supports the following Bluetooth wireless protocols and profiles:

- Bluetooth core technology v4.0
- Battery Profile (BAS)
- Proximity (PXP)
- Device Information Service (DIS)

Bluetooth Wireless Interoperability:

This FOBO device is designed to be interoperating with all Bluetooth wireless products that support compatible profiles and roles including:

- Bluetooth core technology v4.0
- Bluetooth master and slave roles

NCC Statement [警語內容]

低功率電波輻射性電機管理辦法

第十二條 經型式認證合格之低功率射頻電機，非經許可，公司、商號或使用者均不得擅自變更頻率、加大功率或變更原設計之特性及功能。

第十四條 低功率射頻電機之使用不得影響飛航安全及干擾合法通信；經發現有干擾現象時，應立即停用，並改善至無干擾時方得繼續使用。前項合法通信，指依電信法規定作業之無線電通信。

低功率射頻電機須忍受合法通信或工業、科學及醫療用電波輻射性電機設備之干擾。

12 Intellectual Properties

- FOBO™ is a trademark of Salutica Allied Solutions Sdn Bhd. All rights reserved.
- FOBO™ Ultra incorporates a few patent pending technologies solely owned by Salutica Allied Solutions Sdn Bhd.
- Bluetooth® is a registered trademark owned by Bluetooth SIG Inc.
- iPhone® is a registered trademark of Apple Inc.

13 Limited Warranty & Disclaimer

13.1 Warranty

FOBO Ultra comes with a 12 months limited warranty. This Limited Warranty does not cover: 1) products purchased from an unauthorized reseller; 2) products purchased through online auctions; 3) products that are operated in combination with software, peripheral or ancillary equipment such as but not limited to batteries, chargers, adapters, headsets, connector cables, and power supplies ("Ancillary Equipment") not furnished or otherwise certified by Salutica for use with the FOBO products or any damage to the FOBO products or ancillary equipment as a result of such use; 4) damage caused by (a) accident, fire, misuse, neglect, unusual physical or electrical stress, or modification; (b) improper or unauthorized installation, wiring, repair, testing or (c) use of the product outside Salutica's published guidelines; 5) instances in which someone other than Salutica (or its authorized service centres) tests, alters, modifies or services the products in any way; 6) products that have (a) serial numbers or date tags that have been removed or altered, or (b) nonconforming or non-FOBO housings or parts; and 7) consumable spare parts and accessories (unless they are found to be non-functional or broken upon purchase of product).

In order to obtain any warranty service, you agree to bear all shipping charges of the FOBO Ultra device to Salutica's address.

13.2 Disclaimer

SALUTICA MAKES NO OTHER EXPRESS WARRANTY WHETHER WRITTEN OR ORAL AND SALUTICA EXPRESSLY DISCLAIMS ALL WARRANTIES AND CONDITIONS NOT STATED IN THIS LIMITED WARRANTY. TO THE EXTENT ALLOWED BY THE LOCAL LAW OF JURISDICTIONS OUTSIDE MALAYSIA, SALUTICA DISCLAIMS ALL IMPLIED WARRANTIES OR CONDITIONS, INCLUDING ANY IMPLIED WARRANTIES OF MERCHANTABILITY AND FITNESS FOR A PARTICULAR PURPOSE. FOR ALL TRANSACTIONS OCCURRING IN MALAYSIA, ANY IMPLIED WARRANTY OR CONDITION OF MERCHANTABILITY, SATISFACTORY QUALITY, OR FITNESS FOR A PARTICULAR PURPOSE IS LIMITED TO THE WARRANTY PERIOD AS PROVIDED BY SALUTICA IN THE MATERIALS RECEIVED AT THE TIME OF PURCHASE.

No warranty is made that the software provided by Salutica will meet your requirements or will work in combination with any hardware or Applications software products provided by

third parties, that the operation of the software products will be uninterrupted or error free, or that all defects in the software products will be corrected.

13.3 Limitation of Liability

THE MAXIMUM LIABILITY OF SALUTICA UNDER THIS LIMITED WARRANTY IS EXPRESSLY LIMITED TO THE LESSER OF THE PRICE YOU HAVE PAID FOR THE PRODUCT OR THE COST OF REPAIR OR REPLACEMENT OF THAT PRODUCT OR ANY COMPONENT OR PART THAT MALFUNCTION IN CONDITIONS OF NORMAL USE. EXCEPT AS INDICATED ABOVE, IN NO EVENT WILL SALUTICA BE LIABLE FOR ANY DAMAGES CAUSED BY THE FOBO ULTRA PRODUCT OR THE FAILURE OF THE PRODUCT TO PERFORM, INCLUDING ANY LOST PROFITS OR SAVINGS OR SPECIAL, INCIDENTAL, OR CONSEQUENTIAL DAMAGES. SALUTICA IS NOT LIABLE FOR ANY CLAIM MADE BY A THIRD PARTY OR MADE BY YOU FOR A THIRD PARTY. THIS LIMITATION OF LIABILITY APPLIES WHETHER DAMAGES ARE SOUGHT, OR A CLAIM MADE, UNDER THIS LIMITED WARRANTY OR AS A TORT CLAIM (INCLUDING NEGLIGENCE AND STRICT PRODUCT LIABILITY), A CONTRACT CLAIM, OR ANY OTHER CLAIM. THIS LIMITATION OF LIABILITY CANNOT BE WAIVED OR AMENDED BY ANY PERSON. THIS LIMITATION OF LIABILITY WILL BE EFFECTIVE EVEN IF YOU HAVE ADVISED SALUTICA OR AN AUTHORIZED REPRESENTATIVE OF SALUTICA OF THE POSSIBILITY OF ANY SUCH DAMAGES. THIS LIMITATION OF LIABILITY, HOWEVER, WILL NOT APPLY TO CLAIMS FOR PERSONAL INJURY.

13.4 What Law Governs This Warranty

THIS LIMITED WARRANTY IS GOVERNED BY AND CONSTRUED UNDER THE LAWS OF MALAYSIA.